

***ENGLISH***

**AMS-221EN / IP-420  
INSTRUCTION MANUAL**



\* "CompactFlash(TM)" is the registered trademark of SanDisk Corporation, U.S.A.

# CONTENTS

<b>I . MECHANICAL SECTION (WITH REGARD TO THE SEWING MACHINE)...</b>	<b>1</b>
1. SPECIFICATIONS .....	1
2. CONFIGURATION .....	2
3. INSTALLATION .....	3
3-1. Removing the bed fixing bolt.....	3
3-2. Adjusting the safety switch.....	3
3-3. Installing the throat plate auxiliary cover .....	4
3-4. Installing the panel.....	6
3-5. Installing the thread stand .....	6
3-6. Raising the machine head.....	7
3-7. Installing the air hose .....	8
3-8. Cautions for the compressed air supply (source of supply air) facility .....	9
3-9. Installing the eye protection cover.....	10
4. PREPARATION OF THE SEWING MACHINE .....	10
4-1. Lubrication.....	10
4-2. Attaching the needle .....	11
4-3. Threading the machine head .....	11
4-4. Installing and removing the bobbin case .....	11
4-5. Installing the bobbin .....	12
4-6. Adjusting the thread tension .....	12
4-7. Intermediate presser height.....	13
4-8. Adjusting the thread take-up spring .....	13
5. OPERATION OF THE SEWING MACHINE.....	14
5-1. Sewing.....	14
5-2. Needle thread clamp device.....	15
5-3. Adjusting the intermediate stop position of the feeding frame (left) (For the separately-driven feeding frame with a double-stepped stroke function) .....	17
5-4. How to use the plastic blank (supplied with the machine as an accessory) (For the separately-feeding frame with a double-stepped stroke function) .....	17
<b>II .OPERATION SECTION (WITH REGARD TO THE PANEL).....</b>	<b>18</b>
1. PREFACE .....	18
2. WHEN USING IP-420 .....	22
2-1. Name of each section of IP-420 .....	22
2-2. Buttons to be used in common .....	23
2-3. Basic operation of IP-420 .....	24
2-4. LCD display section at the time of sewing shape selection .....	26
(1) Sewing shape data input screen.....	26
(2) Sewing screen .....	28
2-5. Performing sewing shape selection.....	30
2-6. Changing item data.....	32
2-7. Checking pattern shape .....	34
2-8. Performing modification of needle entry point .....	35
(1) Editing the thread tension .....	35
(2) Editing the intermediate presser height .....	36
2-9. How to use temporary stop.....	37

(1) To continue performing sewing from some point in sewing .....	37
(2) To perform re-sewing from the start .....	38
<b>2-10. When setting of sewing product is difficult because of interruption of needle tip .....</b>	<b>39</b>
<b>2-11. Winding bobbin thread .....</b>	<b>40</b>
(1) When performing winding bobbin thread while performing sewing .....	40
(2) When performing winding bobbin thread only .....	40
<b>2-12. Using counter .....</b>	<b>41</b>
(1) Setting procedure of the counter .....	41
(2) Count-up releasing procedure .....	43
(3) How to change the counter value during sewing .....	43
<b>2-13. Performing new register of users' pattern.....</b>	<b>44</b>
<b>2-14. Naming users' pattern .....</b>	<b>45</b>
<b>2-15. Performing new register of pattern button .....</b>	<b>46</b>
<b>2-16. LCD display section at the time of pattern button selection .....</b>	<b>47</b>
(1) Pattern button data input screen.....	47
(2) Sewing screen .....	49
<b>2-17. Performing pattern button No. selection .....</b>	<b>51</b>
(1) Selection from the data input screen .....	51
(2) Selection by means of the shortcut button.....	52
<b>2-18. Changing contents of pattern button.....</b>	<b>53</b>
<b>2-19. Copying pattern button .....</b>	<b>54</b>
<b>2-20. Changing sewing mode.....</b>	<b>55</b>
<b>2-21. LCD display section at the time of combination sewing.....</b>	<b>56</b>
(1) Pattern input screen.....	56
(2) Sewing screen .....	58
<b>2-22. Performing combination sewing .....</b>	<b>60</b>
(1) Selection of combination data.....	60
(2) Creating procedure of the combination data.....	61
(3) Deleting procedure of the combination data .....	62
(4) Deleting procedure of the step of the combination data .....	62
<b>2-23. Using the simple operation mode .....</b>	<b>63</b>
<b>2-24. LCD display when the simple operation is selected.....</b>	<b>64</b>
(1) Data input screen (individual sewing) .....	64
(2) Sewing screen (individual sewing).....	67
(3) Data input screen (combination sewing).....	70
(4) Sewing screen (combination sewing) .....	72
<b>2-25. Changing memory switch data.....</b>	<b>74</b>
<b>2-26. Using information .....</b>	<b>75</b>
(1) Observing the maintenance and inspection information .....	75
(2) Releasing procedure of the warning .....	76
<b>2-27. Using communication function .....</b>	<b>77</b>
(1) Handling possible data .....	77
(2) Performing communication by using the media.....	77
(3) Performing communication by using USB .....	77
(4) Take-in of the data .....	78
(5) Taking in plural data together.....	79
<b>2-28. Performing formatting of the media .....</b>	<b>81</b>
<b>2-29. Operation at the time of X/Y motor position slip.....</b>	<b>82</b>
(1) When the error is displayed during sewing.....	82
(2) When the error is displayed after end of sewing.....	83
(3) When the rest switch is not displayed.....	83

<b>3. MEMORY SWITCH DATA LIST .....</b>	<b>84</b>
3-1. Data list .....	84
3-2. Initial value list .....	90
<b>4. ERROR CODE LIST .....</b>	<b>92</b>
<b>5. MESSAGE LIST .....</b>	<b>99</b>
<b>III. MAINTENANCE OF SAWING MACHINE .....</b>	<b>102</b>
<b>1. MAINTENANCE.....</b>	<b>102</b>
1-1. Adjusting the height of the needle bar (Changing the length of the needle) .....	102
1-2. Adjusting the needle-to-shuttle relation .....	102
1-3. Adjusting the height of the feeding frame .....	104
1-4. Adjusting the vertical stroke of the intermediate presser.....	104
1-5. The moving knife and counter knife.....	105
1-6. Needle thread clamp device.....	106
1-7. Thread breakage detector plate .....	106
1-8. Replenishing the designated places with grease .....	107
(1) Location where exclusive grease is provided .....	108
(2) Points to be applied with JUKI Grease A .....	108
(3) Points to be applied with JUKI Grease B.....	110
1-9. Draining waste oil .....	112
1-10. Amount of oil supplied to the hook.....	112
1-11. Replacing the fuse .....	112
1-12. Changing the voltage of 100←→200V.....	113
1-13. Troubles and corrective measures (Sewing conditions).....	114
<b>2. OPTIONAL.....</b>	<b>116</b>
2-1. Table of Needle hole guide.....	116
2-2. Silicon oil tank .....	116

# I. MECHANICAL SECTION (WITH REGARD TO THE SEWING MACHINE)

## 1. SPECIFICATIONS

1	Sewing area	X (lateral) direction AMS-221EN-2516 : 250 mm × 160 mm AMS-221EN-3020 : 300 mm × 200 mm	Y (longitudinal) direction
2	Max. sewing speed	2,800 sti/min (When sewing pitch is 3.5 mm or less)	
3	Stitch length	0.1 to 12.7 mm (Min. resolution : 0.05 mm)	
4	Feed motion of feeding frame	Intermittent feed (2-shaft drive by stepping motor)	
5	Needle bar stroke	41.2 mm	
6	Needle	GROZ-BECKERT 134, 135x17, ORGAN needle DPx5, DPx17	
7	Lift of feeding frame	Max. 30mm	
8	Intermediate presser stroke	4 mm (Standard) (0 to 10 mm)	
9	Lift of intermediate presser	20 mm	
10	Intermediate presser DOWN position variable	Standard 0 to 3.5 mm (Max. 0 to 7.0 mm)	
11	Shuttle	Double-capacity semi-rotary hook	
12	Lubricating oil	New Defrix Oil No. 2 (Supplied by oiler)	
13	Memory of pattern data	Main body, Media • Main body : Max. 999 patterns (Max. 50,000 stitches/pattern) • Media : Max. 999 patterns (Max. 50,000 stitches/pattern)	
14	Temporary stop facility	Used to stop machine operation during a stitching cycle.	
15	Enlarging / Reducing facility	Allows a pattern to be enlarged or reduced on the X axis and Y axis independently when sewing a pattern. Scale : 1% to 400% times (0.1% steps)	
16	Enlarging / Reducing method	Pattern enlargement / reduction can be done by increasing / decreasing either stitch length or the number of stitches. (Increasing/decreasing stitch length only can be performed when pattern button is selected.)	
17	Max. sewing speed limitation	200 to 2,800 sti/min (Scale : 100 sti/min steps)	
18	Pattern selection facility	Pattern No. selection method (Main body : 1 to 999, Media : 1 to 999)	
19	Bobbin thread counter	UP/DOWN method (0 to 9,999)	
20	Sewing counter	UP/DOWN method (0 to 9,999)	
21	Memory back-up	In case of a power interruption, the pattern being used will automatically be stored in memory.	
22	2nd origin setting facility	Using jog keys, a 2nd origin (needle position after a sewing cycle) can be set in the desired position within the sewing area. The set 2nd origin is also stored in memory.	
23	Sewing machine motor	Servo-motor	
24	Dimensions	AMS-221EN-2516 : 1,200mm (W) x 1,000mm (L) x 1,200mm (H) (Excluding thread stand) AMS-221EN-3020 : 1,200mm (W) x 1,070mm (L) x 1,200mm (H) (Excluding thread stand)	
25	Mass (gross mass)	AMS-221EN-2516 : 201 kg AMS-221EN-3020 : 210 kg	
26	Power consumption	700 VA	
27	Operating temperature range	5°C to 35°C	
28	Operating humidity range	35 % to 85 % (No dew condensation)	
29	Line voltage	Rated voltage ±10% 50 / 60 Hz	
30	Air pressure used	AMS-221EN-2516 : 0.5 to 0.55 MPa (Max. 0.55 MPa) AMS-221EN-3020 : 0.35 to 0.4 MPa (Max. 0.55 MPa)	
31	Air consumption	1.8 dm <sup>3</sup> / min (ANR)	
32	Needle highest position stop facility	After the completion of sewing, the needle can be brought up to its highest position.	
33	Noise	- Equivalent continuous emission sound pressure level (L <sub>pA</sub> ) at the workstation: A-weighted value of 85 dB; (Includes L <sub>pA</sub> = 2.5 dB); according to ISO 10821- C.6.3 -ISO 11204 GR2 at 2,800 sti/min. - Sound power level (L <sub>wA</sub> ); A-weighted value of 94 dB; (Includes K <sub>wA</sub> = 2.5 dB); according to ISO 10821- C.6.3 -ISO 11204 GR2 at 2,800 sti/min Time required for sewing: 2.2 sec, using Pattern No. 102	

## 2. CONFIGURATION

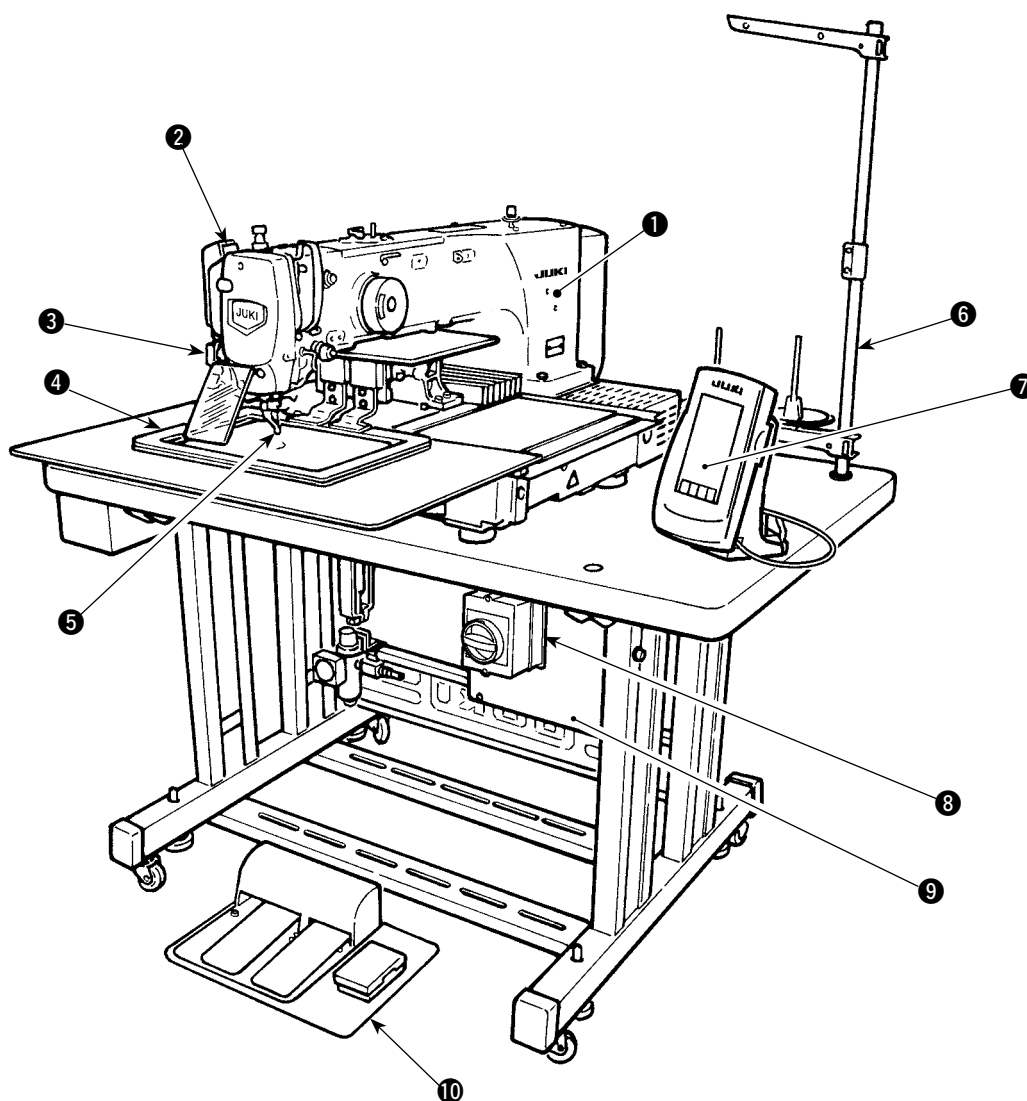

- ① Machine head
- ② Wiper switch
- ③ Temporary stop switch
- ④ Feeding frame
- ⑤ Intermediate presser
- ⑥ Thread stand
- ⑦ Operation panel (IP-420)
- ⑧ Power switch
- ⑨ Control box
- ⑩ Foot pedal

Air regulator

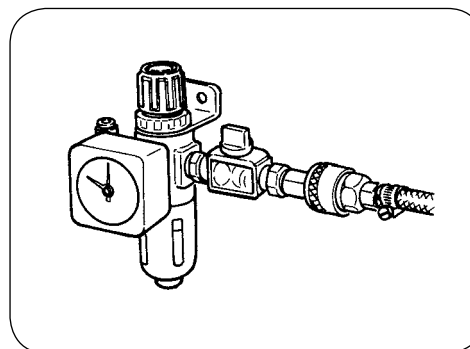

## 3. INSTALLATION

### 3-1. Removing the bed fixing bolt

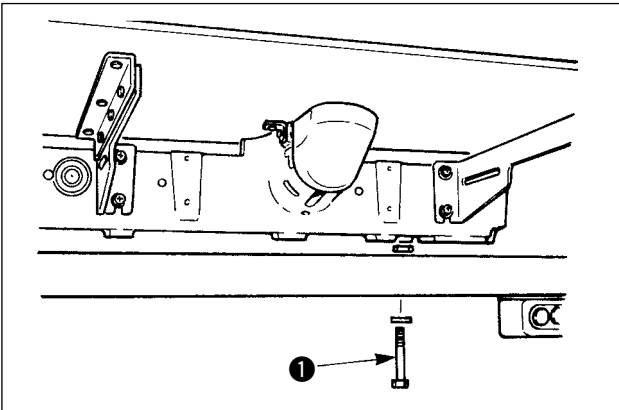

Remove bed fixing bolt ❶. This bolt is necessary to transport the sewing machine.

### 3-2. Adjusting the safety switch

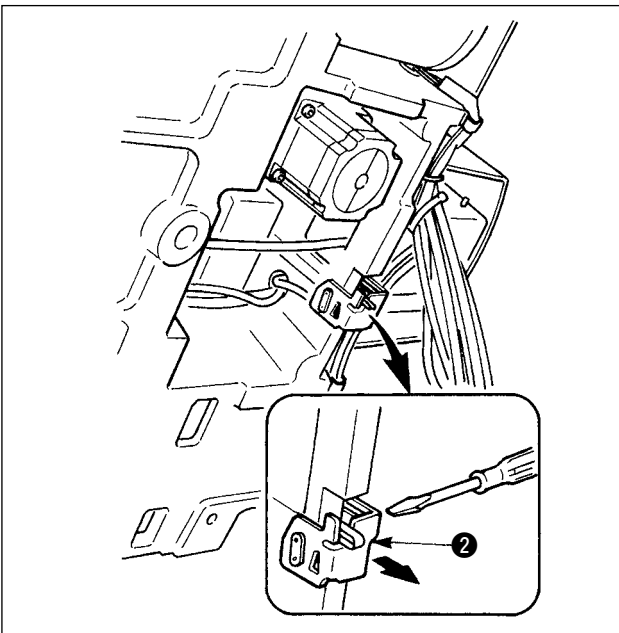

In case error 302 occurs when the sewing machine works after setup, loosen the safety switch fitting screw with a screwdriver, and lower the switch ❷ to the downside of the sewing machine.

### 3-3. Installing the throat plate auxiliary cover



1. The stay and the like are set to the throat plate auxiliary cover and the fitting screws and washers to the bed are packed together with the accessories at the time of delivery.
2. When using the cover sheet supplied as accessories, paste it to the throat plate auxiliary cover before installing.

[When using area 2516]

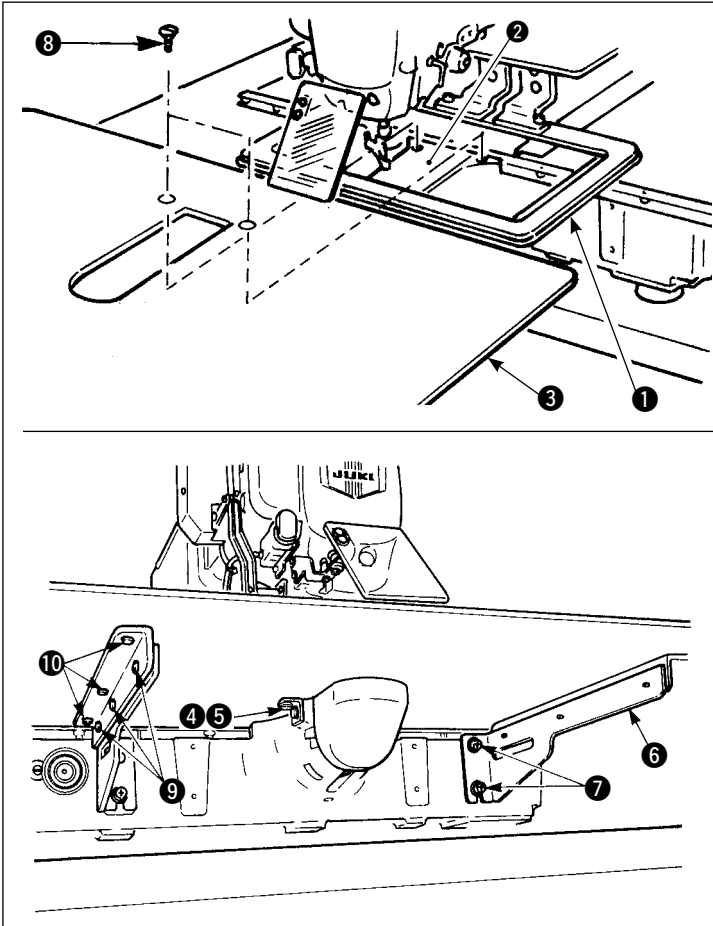

- 1) Move the cloth feed base to the rear, and place throat plate auxiliary cover **3** from between lower plate **1** and throat plate **2**. At this time, be careful not to bend lower plate **1**.
- 2) Temporarily fix throat plate auxiliary cover **3** with throat plate auxiliary cover setscrew **5** and washer **4**.
- 3) Temporarily fix throat plate auxiliary cover support **6** to the machine bed with setscrews (M6) **7**.
- 4) Fix the throat plate auxiliary cover to the bed with two oval counter-sunk screws **8**.
- 5) Refer to the items of the caution, perform positioning of the throat plate auxiliary cover, and fix setscrews **5** and **7**. When the positioning is not enough, loosen setscrews **9** and **10** once, and perform the positioning.



[When using area 3020]

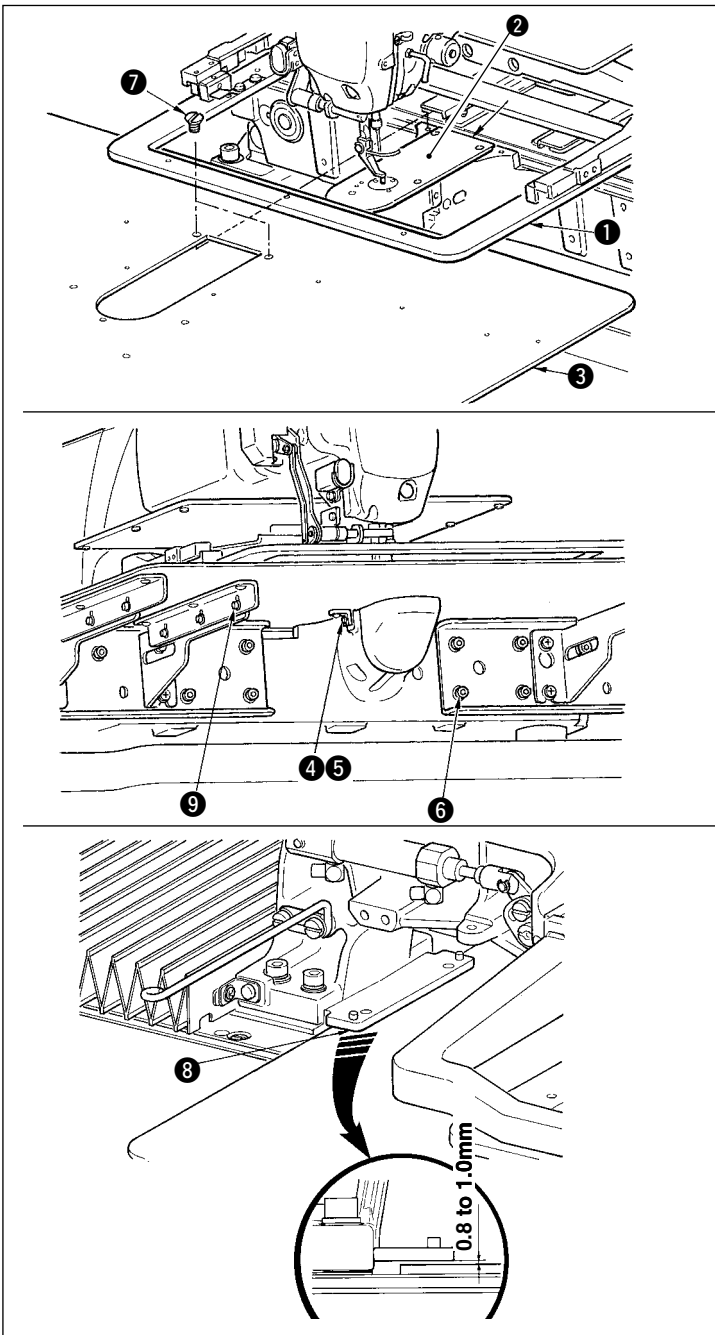

- 1) Move the cloth feed base to the rear, and place throat plate auxiliary cover (asm.) ③ from between lower plate ① and throat plate ②. At this time, be careful not to bend or damage lower plate ①.
- 2) Temporarily fix throat plate auxiliary cover (asm.) ③ with throat plate auxiliary cover setscrew ⑤ and washer ④.
- 3) Temporarily fix throat plate auxiliary cover (asm.) ③ to the machine bed with throat plate auxiliary cover support setscrews ⑥ (10 pcs.).
- 4) Fix throat plate auxiliary cover (asm.) ③ to the machine bed with two counter-sunk screws ⑦.
- 5) Move the cloth feed base to the left front, move up and down throat plate auxiliary cover (asm.) ③ so that a distance of 0.8 to 1.0 mm is provided between the bottom surface of lower plate installing base ⑧ and the top surface of throat plate auxiliary cover (asm.) ③, and fix setscrews ⑥.
- 6) Perform the similar work by moving the cloth feed base to the right front.
- 7) Fix throat plate auxiliary cover setscrew ⑤.
- 8) Referring to the caution below, perform positioning of the throat plate auxiliary cover. When the positioning is not performed enough, perform the positioning after loosening once throat plate auxiliary cover setscrew ⑤ and throat plate auxiliary cover base setscrews ⑨.

**Caution**

1. Fix the throat plate auxiliary cover ③ so that is higher than the throat plate ② (within 0.3 mm). When it is lower than the throat plate ②, needle breakage or the like due to the defective feed will be caused.
2. Confirm by putting a ruler or the like that the throat plate auxiliary cover ③ is horizontally installed. If not, throat plate auxiliary cover ③ and lower plate ① come in contact partially with each other, and abnormal worn-out will be caused.

### 3-4. Installing the panel

#### 1) Installing the IP-420

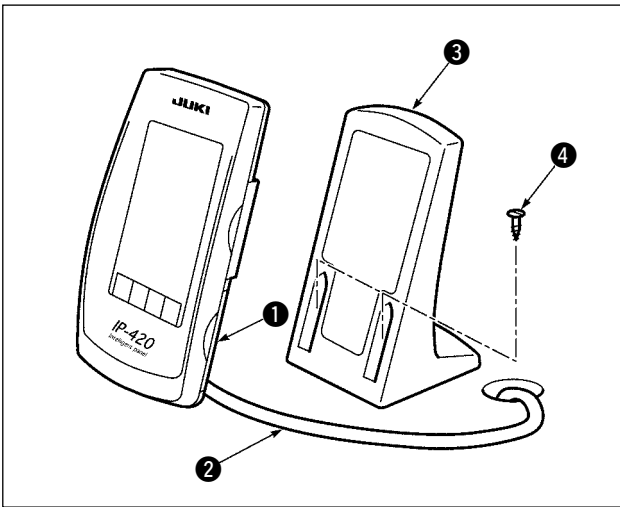

- 1) Open cover ❶ and remove cable ❷ once. Then connect it again to the panel on the top surface of the table after passing it through the hole in the table.
- 2) Fix operation panel installing plate ❸ to an optional place on the table with two wood screws ❹.



**Install the panel at the position where X-move cover or head grip does not interfere with it since breakage of the panel will be caused.**

### 3-5. Installing the thread stand

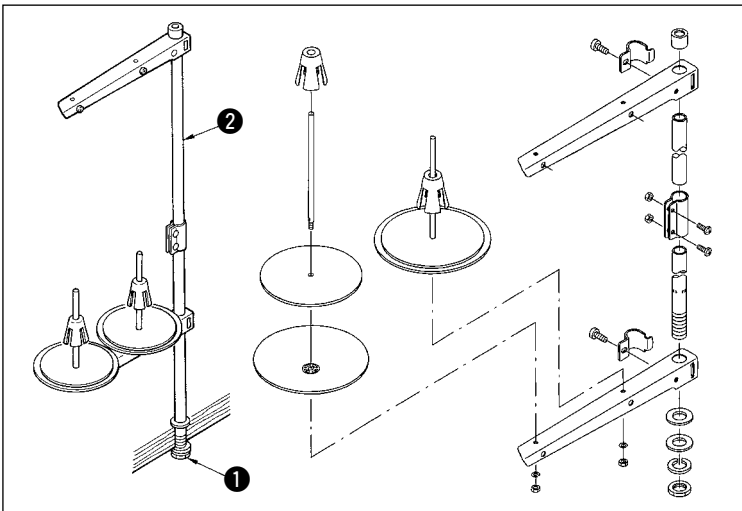

- 1) Assemble the thread stand, and put it in the hole in the top left corner of the machine table.
- 2) Tighten locknut ❶ to fix the thread stand.
- 3) When ceiling wiring is possible, pass the power cord through spool rest rod ❷.

### 3-6. Raising the machine head

**WARNING :**



Tilt/raise the sewing machine head with both hands taking care not to allow your fingers to be caught in the head.  
Turn OFF the power before starting the work so as to prevent accidents caused by abrupt start of the sewing machine.

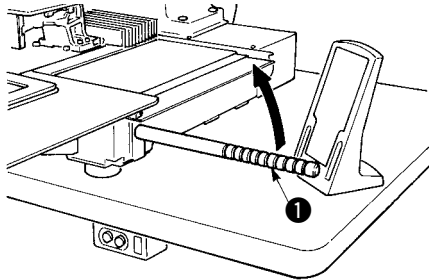
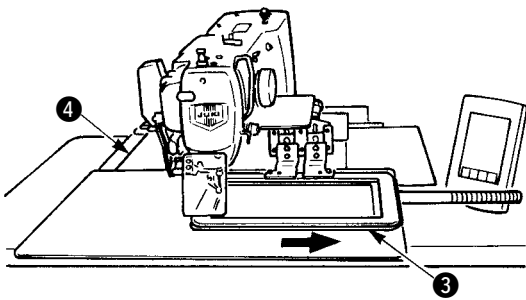

Maintenance position of the sewing machine

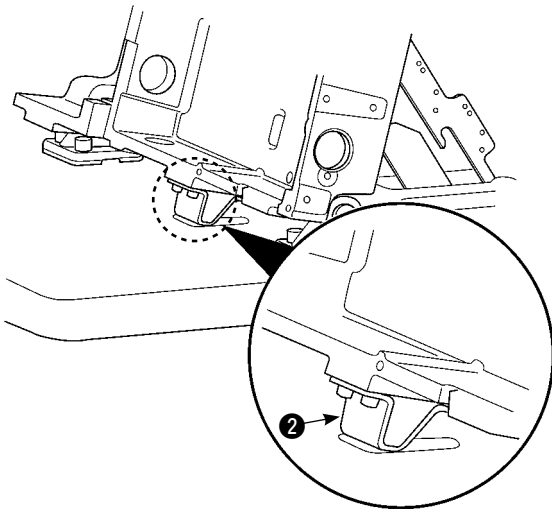

**[When using area 2516]**

To carry out work with the sewing machine raised, follow the steps of procedure described below.

1. Move feeding frame **3** to the rightmost position and fix it there. Then mount machine head grip **1** supplied with the unit by fully screwing it into position.
2. Holding machine head grip **1**, lift the sewing machine in the direction of the arrow until the maintenance position (where machine head support **2** comes in contact with the table) is reached.



- If a 20 kg or more load is necessary to be applied to the position of machine head grip **1** in order to lift the machine head, gas spring **5** has outgassed. Be sure to replace the gas spring with a new one.
- While raising the sewing machine, gas spring **5** works to move the sewing machine in the direction of the arrow when the sewing machine is inclined by approximately 45 degrees of an angle with respect to the table. It is therefore necessary to lift the sewing machine until the maintenance position is reached while supporting the sewing machine with both hands.

3. Turn stopper release lever **6** in the direction of the arrow to secure the sewing machine.



Never operate stopper release lever **6** at any position other than the maintenance position so as not to allow your hand or other part of body to be caught between the sewing machine and the table.

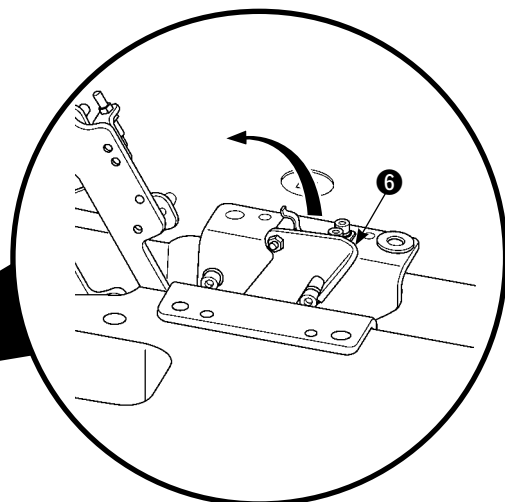
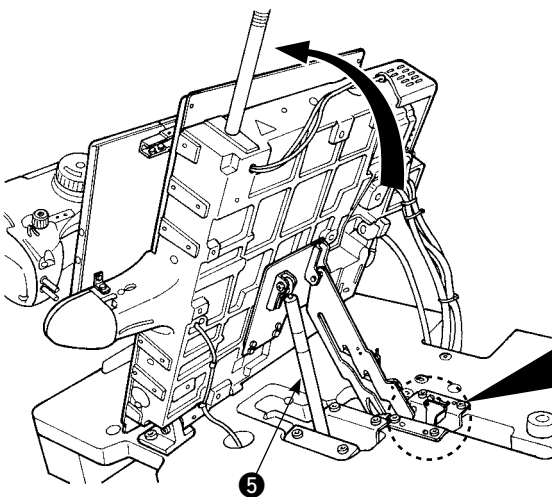

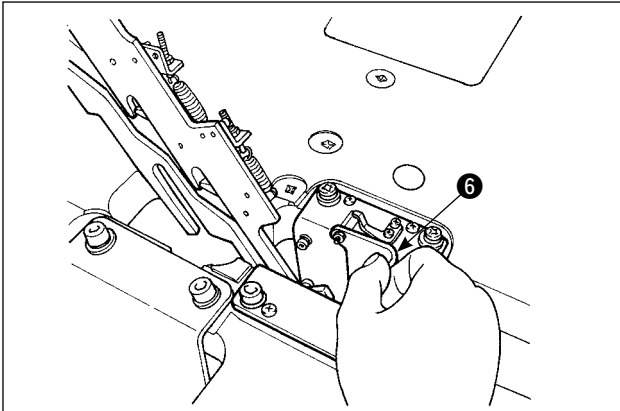

Machine head in the fixed state

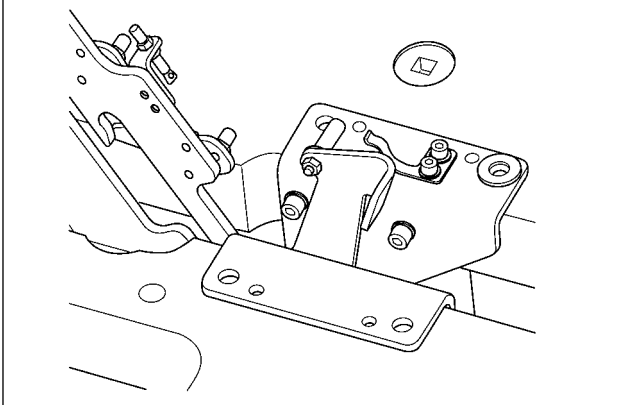

To return the sewing machine to its initial position, follow the steps of procedure described below.

1. Return stopper release lever ⑥ to its initial position. (Return the lever until it is fixed.)
2. Carefully return machine head grip ① to its initial position with both hands.



- While returning the sewing machine to its initial position, gas spring ⑤ works when the sewing machine is inclined by approximately 70 degrees of an angle to hold the machine at that position before the machine reaches its initial position. Then, further apply force in the returning direction to return the sewing machine to its initial position.
- If you return the sewing machine to its initial position swiftly, the sewing machine open/close lock mechanism will work. In this case, slightly lift the sewing machine from the position where it is locked to reset the lock mechanism. Then, carefully return the sewing machine to its initial position again.

### [When using area 3020]

The sewing machine of area 3020 cannot be raised unless the throat plate auxiliary cover (asm.) is removed. Raise the sewing machine after removing the throat plate auxiliary cover (asm.) referring to “I-3-3. Installing the throat plate auxiliary cover”, p.4.

The raising procedure after removing is the same to [When using area 2516].

When using the sewing machine, install the throat plate auxiliary cover (asm.) referring to “I-3-3. Installing the throat plate auxiliary cover”, p.4.



1. To prevent the sewing machine from falling, be sure to raise the machine head after fixing table/stand (casters) at the leveled place so as to prevent it from moving.
2. Be sure to raise the machine after shifting feeding frame ③ to the rightmost position since X-feed cover ④ interferes with the machine table causing breakage.
3. When the machine is raised, clean portion ① of the bottom face of the machine to prevent the surface of the machine table from being stained with oil.

### 3-7. Installing the air hose

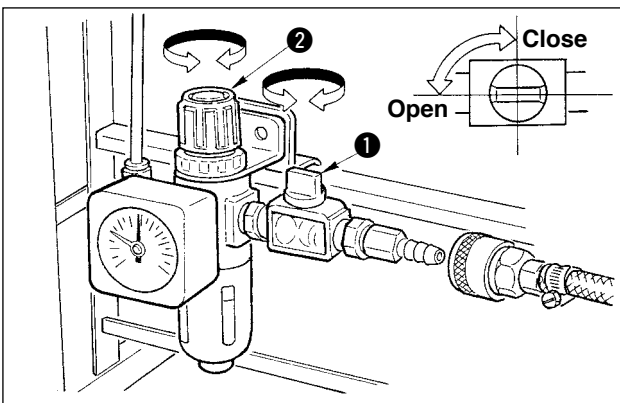

- 1) Connecting the air hose  
Connect the air hose to the regulator .
  - 2) Adjustment of air pressure  
Open air cock ①, pull up and turn air adjustment knob ② and adjust so that air pressure indicates 0.5 to 0.55 MPa (Max. 0.55 MPa). Then lower the knob and fix it.
- \* Close air cock ① to expel air.

### 3-8. Cautions for the compressed air supply (source of supply air) facility

As large as 90 % of failures in pneumatic equipment (air cylinders, air solenoid valves) are caused by "contaminated air."

Compressed air contains lots of impurities such as moisture, dust, deteriorated oil and carbon particles. If such "contaminated air" is used without taking any measures, it can be a cause of troubles, inviting reduction in productivity due to mechanical failures and reduced availability.

Be sure to install the standard air supply facility shown below whenever the machine provided with pneumatic equipment is used.

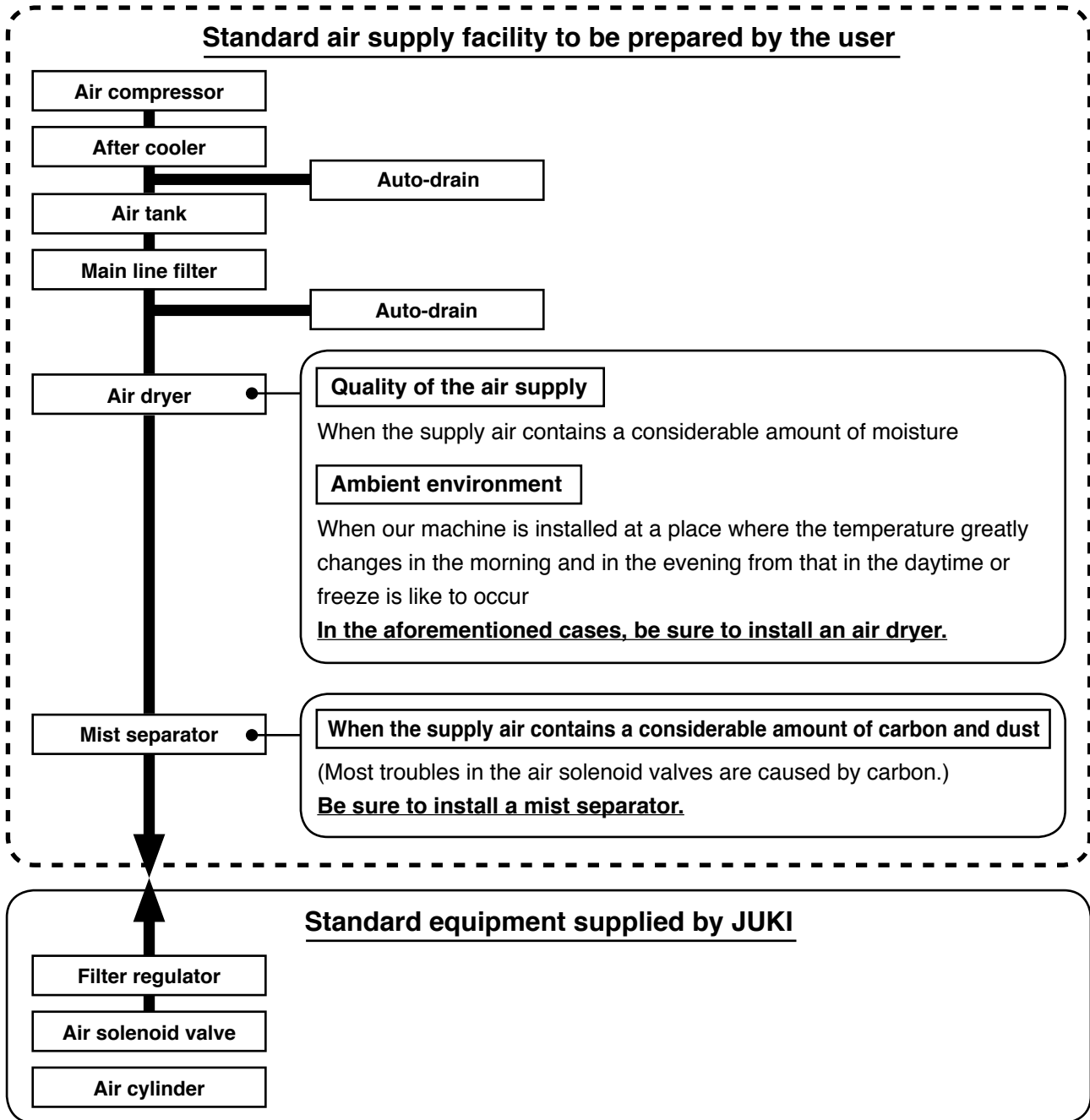

#### Cautions for main piping

- Be sure to slope main piping by a falling gradient of 1 cm per 1 m in the direction of air flow.
- If the main piping is branched off, the outlet port of the compressed air should be provided at the top part of the piping using a tee in order to prevent drain settling inside the piping from flowing out.
- Auto drains should be provided at all lower points or dead ends in order to prevent the drain from settling in those parts.



### 3-9. Installing the eye protection cover



#### WARNING :

Be sure to attach this cover to protect the eyes from the disperse of needle breakage.

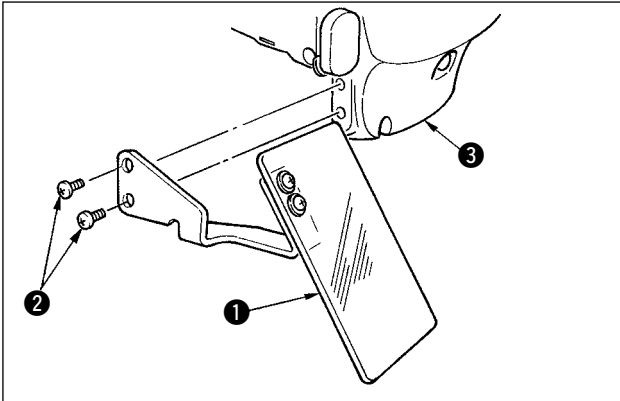

Use eye protection cover ① after securely attaching it on face plate cover ③ with screw ②.

## 4. PREPARATION OF THE SEWING MACHINE

### 4-1. Lubrication



#### WARNING :

Turn OFF the power before starting the work so as to prevent accidents caused by abrupt start of the sewing machine.

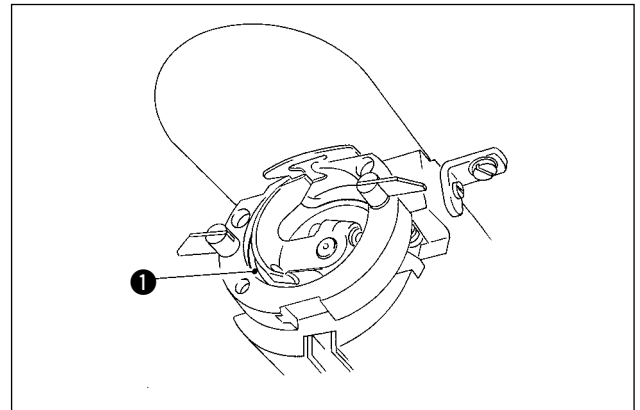
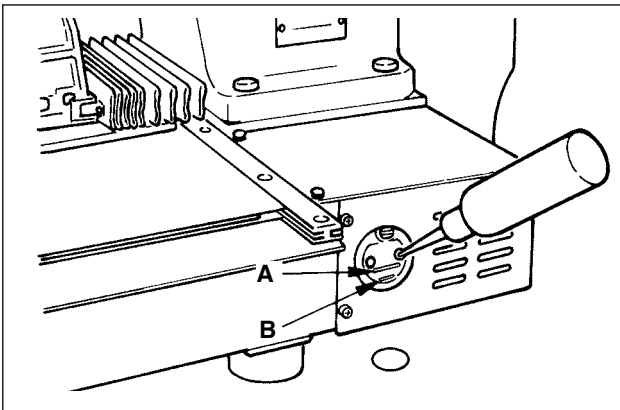

- 1) Check that the place between lower line **B** and upper line **A** is filled with oil. Fill there with oil using the oiler supplied with the machine as accessories when oil is short.
- 2) Apply one drop of oil to the hook race ① part to spread on it.



The oil tank which is filled with oil is only for lubricating to the hook portion. It is possible to reduce the oil amount when the number of rotation used is low and the oil amount in the hook portion is excessive. (Refer to “[III-1-10. Amount of oil supplied to the hook](#)” p.112.)



1. Do not lubricate to the places other than the oil tank and the hook of Caution 2 below. Trouble of components will be caused.
2. When using the sewing machine for the first time or after an extended period of disuse, use the machine after lubricating a small amount of oil to the hook portion. (For removing the shuttle, see “[III-1-2. Adjusting the needle-to-shuttle relation](#)” p.102.)

## 4-2. Attaching the needle



### WARNING :

Turn OFF the power before starting the work so as to prevent accidents caused by abrupt start of the sewing machine.

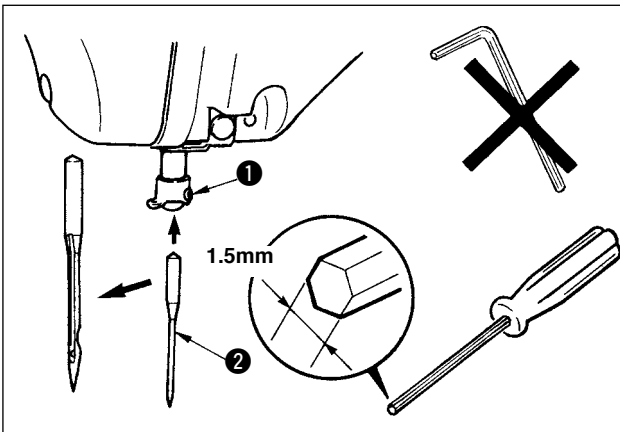

Loosen setscrew ① and hold needle ② with the long groove facing toward you. Then fully insert it into the hole in the needle bar, and tighten setscrew ①.

When tightening setscrew ①, be sure to use the screwdriver (Part No. : 40032763) supplied as accessories.



Do not use L-shaped hexagon wrench key. There is a danger of breaking set-screw ①.

## 4-3. Threading the machine head



### WARNING :

Turn OFF the power before starting the work so as to prevent accidents caused by abrupt start of the sewing machine.

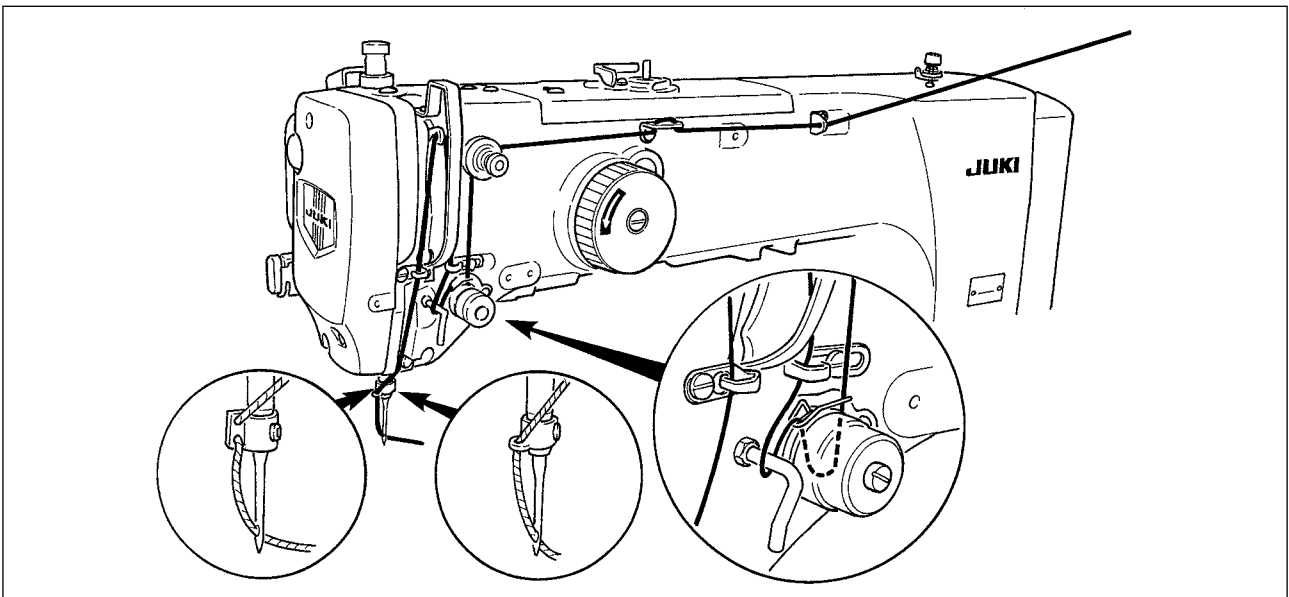

## 4-4. Installing and removing the bobbin case



### WARNING :

Turn OFF the power before starting the work so as to prevent accidents caused by abrupt start of the sewing machine.

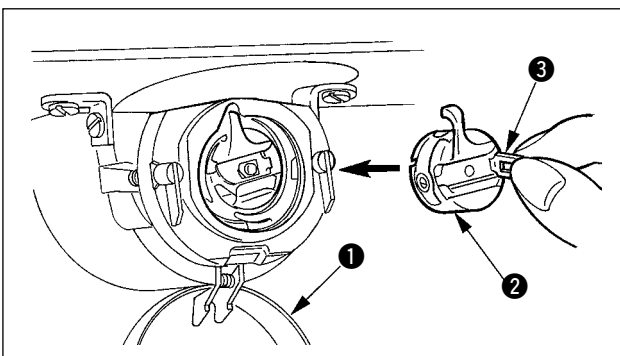

- 1) Open hook cover ①.
- 2) Raise latch ③ of bobbin case ②, and remove the bobbin case.
- 3) When entering bobbin case, insert it with the latch tilted until "click" sounds.



If it is not fully inserted, bobbin case ② may slip off during sewing.

## 4-5. Installing the bobbin



### WARNING :

Turn OFF the power before starting the work so as to prevent accidents caused by abrupt start of the sewing machine.

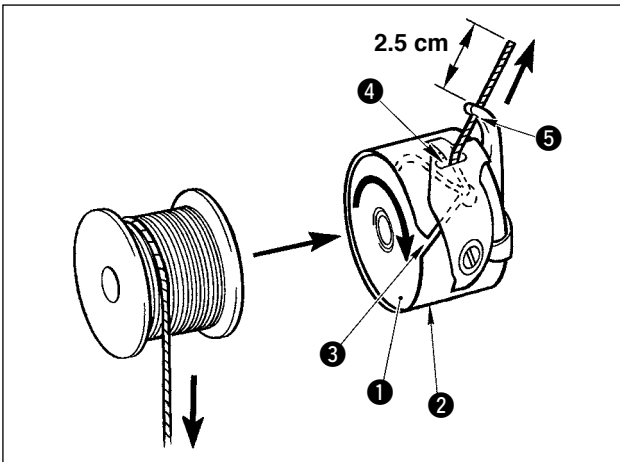

- 1) Set the bobbin ① into bobbin case ② in the direction shown in the figure.
- 2) Pass the thread through thread slit ③ of bobbin case ②, and pull the thread as it is. By so doing, the thread will pass under the tension spring and be pulled out from thread hole ④.
- 3) Pass the thread through thread hole ⑤ of the horn section, and pull out the thread by 2.5 cm from the thread hole.



If the bobbin is installed in the bobbin case orienting the reverse direction, the bobbin thread pulling out will result in an inconsistent state.

## 4-6. Adjusting the thread tension

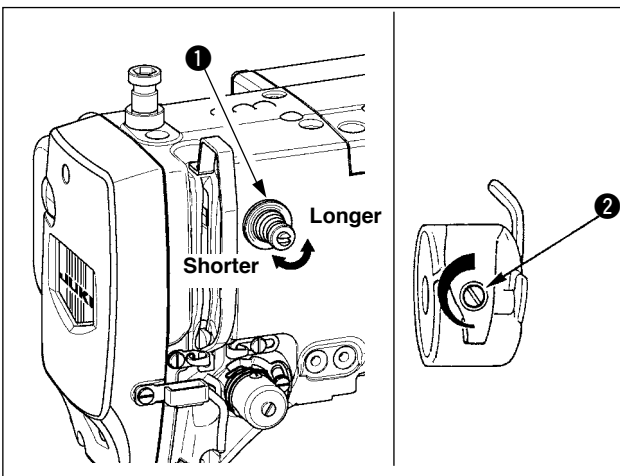

If thread tension controller No. 1 ① is turned clockwise, the length of remaining thread on the needle after thread trimming will be shorter. If it is turned counterclockwise, the length will be longer. Shorten the length to an extent that the thread is not slipped off.

Adjust needle thread tension from the operation panel and bobbin thread tension with ②.

## Adjusting the needle thread tension

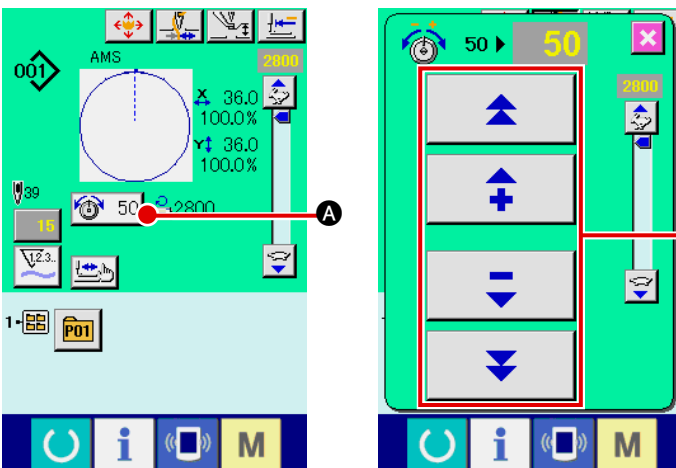

- 1) Select THREAD TENSION button **A** in the sewing screen.
- 2) Set a needle thread tension using PLUS/MINUS (+/-) button **B**. There is a setting range of 0 to 200. When the set value is increased, the tension becomes higher.

\* When the set value is 50 at the time of standard delivery, the thread tension is adjusted so that H type is 2.35N and S type is 1.47N (spun thread #50).  
(When thread tension No. 1 is released)



## 4-7. Intermediate presser height



1. When raising the intermediate presser height, turn the pulley by hand to lower the needle bar, and confirm that the needle bar does not interfere with the intermediate presser. (When using DP X 5 needle, use the sewing machine with the height of 3.5 mm or less.)
2. Take care not to get your hands and fingers caught in the feeding frame or intermediate presser.

[IP-420]

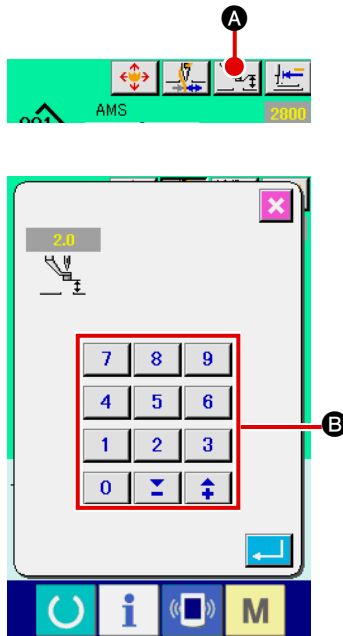

Press INTERMEDIATE PRESSER SETTING button **A** and adjust with TEN keys **B** so that the clearance between the bottom end of intermediate presser and the cloth is 0.5 mm (thickness of thread used).

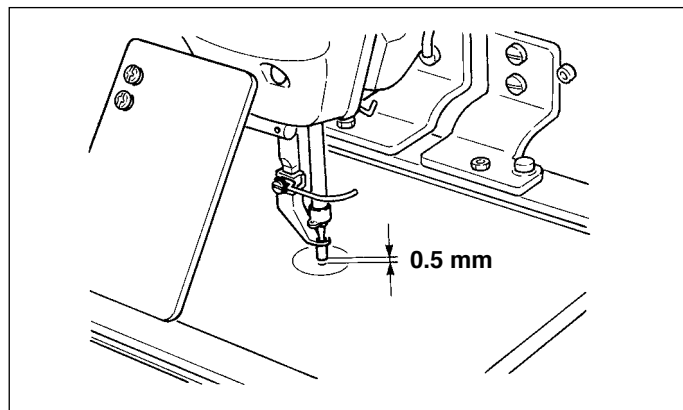

1. Setting range of the intermediate presser is up to the standard of 3.5 mm. However, when using DP X 17 needle for H type or the like, the setting range can be changed up to max. 7 mm with memory switch U112.
2. When increasing the height of intermediate presser or making the needle size thicker, confirm the clearance between the wiper and the components. Wiper cannot be used unless the clearance is secured. Turn OFF the wiper switch. Besides, note that the wiper is set so as to sweep at the position where the intermediate presser is in the lowest position in spite of the setting of intermediate presser height at the time of delivery. (Memory switch U 105)

## 4-8. Adjusting the thread take-up spring

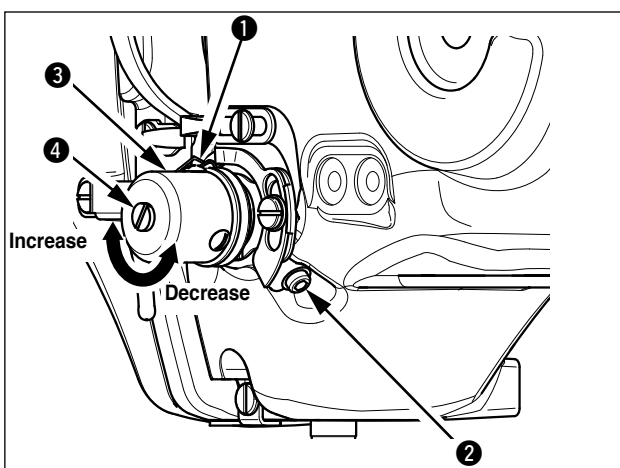

- 1) Adjusting the stroke  
Loosen setscrew **2**, and turn thread tension asm. **3**. Turning it clockwise will increase the moving amount and the thread drawing amount will increase.
- 2) Adjusting the pressure  
To change the pressure of the thread take-up spring **1**, insert a thin screwdriver into the slot of thread tension post **4** while screw **2** is tightened, and turn it. Turning it clockwise will increase the pressure of the thread take-up spring. Turning it counterclockwise will decrease the pressure.

## 5. OPERATION OF THE SEWING MACHINE

### 5-1. Sewing

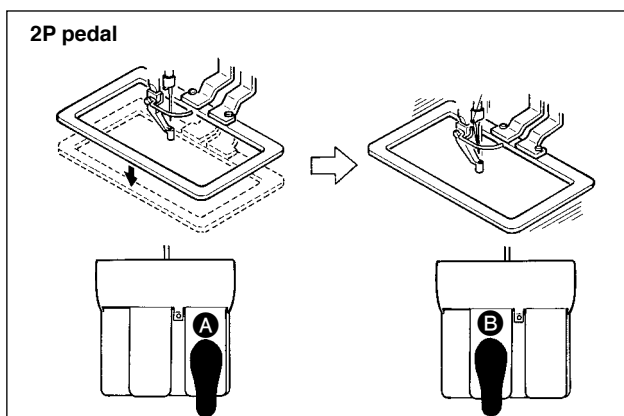

#### [In case of 2P pedal]

- 1) Set a workpiece on the sewing machine.
- 2) Depress the pedal switch **A**, and the feeding frame will come down. Depress it again, and the feeding frame will go up.
- 3) Depress the pedal switch **B** after the feeding frame has come down and the sewing machine will start sewing.
- 4) After the sewing machine completes sewing, the needle point will return to the start point and the feeding frame will go up.

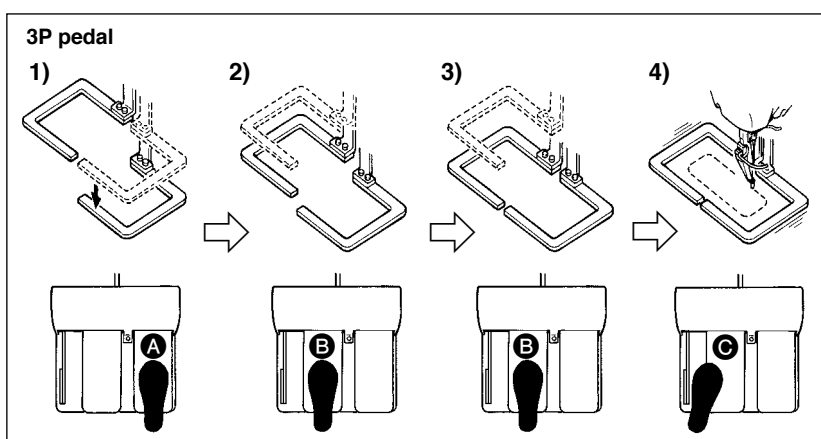

#### [In case of 3P pedal]

\* Steps 1), 2) and 3) can be operated in the reverse order by setting of memory switch U81.

- 1) Place a sewing product under the feeding frame. Depress pedal **A** of the pedal switch, and the feeding frame (right) will come down to clamp the sewing product.
- 2) Place a workpiece to be sewn on the sewing product under the feeding frame (left). Lightly depress pedal **B**, and the feeding frame (left) will stop in its intermediate stop position. Release the pedal, and the feeding frame (left) will rise back to the initial position.
- 3) Position the workpiece. Further depress pedal **B**, and the feeding frame (left) will come down to the lowest position to clamp the workpiece. Re-depress pedal **B** until it will go no further, the feeding frame (left) will return to the intermediate stop position.
- 4) Depress pedal **C** when both frames of the feeding frame rest in the lowest position, and the sewing machine will start sewing.

## 5-2. Needle thread clamp device

By actuating the needle thread clamp device, trouble of sewing at the high-speed start (needle thread slip-off, stitch skipping or needle thread stain) is prevented, and can reduce gathering (bird's nest) of needle thread on the wrong side of cloth while keeping stable sewing. When mounting the IP-420, changeover of motion ON/OFF is performed with  key.

When the needle thread clamp device is OFF, the machine automatically operates at slow-start.



**When memory switch No. 35 is "1" (prohibited), the thread clamp does not work. In addition,  key is ineffective.**

### \* Matters that demand special attention when using the needle thread clamp device

For the thread clamp unit, there are S type and H type in accordance with the sewing types. Refer the respective types and the contents of the memory switches that can be set to the list below.

Sewing machine type	Thread clamp unit type	Memory switch	
		U69	U70
AMS-221ENSL	S type	0 : S type (standard)	0 : Front 1 : Rear (standard)
AMS-221ENHS AMS-221ENHL	H type	1 : H type thin thread (standard)(#50 to #8) 2 : H type intermediate (#20 to #5) 3 : H type thick thread (#5 to #2)	0 : Front 1 : Rear (standard)

#### [Regarding H type thread clamp unit]

Change the set value of memory switch U69 in accordance with the thickness of needle thread. The set value has been set to 1 : H type thin thread at the time of delivery. Commendable value is Set value : 1 for thread count #50 to #8, Set value : 2 for thread count #20 to #5, and Set value : 3 for thread count #5 to #2. (The value will change in accordance with the kind and thickness of the actual thread and the kinds of materials to be sewn.) Set the value by adjusting to the state of needle thread on the wrong side of materials.

In addition, it is possible to select the thread clamp position by means of memory switch U70. When using thick thread of thread count #5 to #2, and rolling-in or tucking at the start of sewing occurs, set the set value to 1 : Rear and use the machine.



**Use the set value of the memory switch which is adjusted to the thread clamp unit type. (For S type thread clamp unit, the set value of U69 and U70 can use nothing but only "0".) When the setting is wrong, the thread clamp fails to properly function. So, be careful.**

(1) When with thread clamp (motion), use the sewing machine after adjusting the needle thread length at the start of sewing to 40 to 50 mm. When the needle thread length is too long, the needle thread end held with the needle thread clamp may be rolled in the seams.

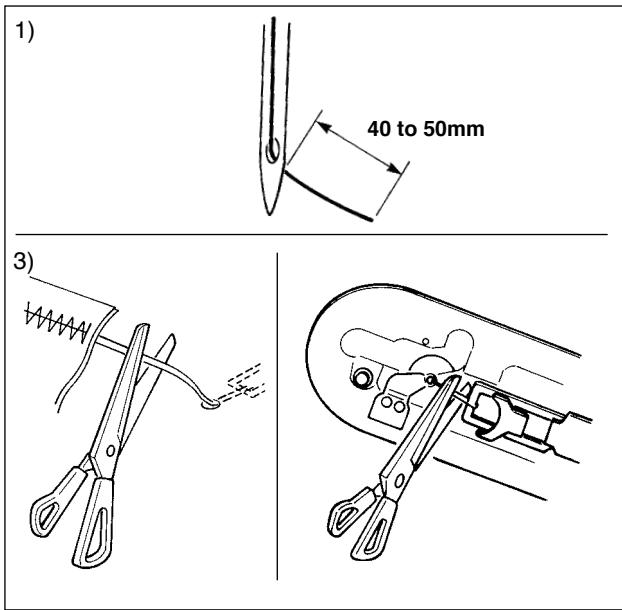

- 1) In case of with the needle thread clamp, the standard of the length of needle thread is 40 to 50 mm.
- To prevent the thread from slipping off from the needle eyelet at the beginning of sewing or to prevent stitch skipping from the first stitch  
→ Adjust the length of needle thread longer within the range.
  - To prevent stitch skipping within the second to tenth stitches from the beginning of sewing  
→ Adjust the length of needle thread shorter within the range



**When needle thread is excessively long at the time of using the thick thread, the end of needle thread held with the needle thread clamp is rolled in the seams, and slip of position of material may occur or needle breakage may be caused.**

(2) When the thread clamp is used, and bobbin thread at the sewing start appears on the right side of material, reduce thread tension at the sewing start (2 to 3 stitches) and bobbin thread becomes less conspicuous.

[Example of setting]

Tension of 1 to 2 stitches at the sewing start is "20" when sewing tension setting is "35".

\* For setting of tension at the start of sewing, see of "[II-2-8.\(1\) Changing the thread tension value](#)" p.35.



1. Thread at the start of sewing may be rolled in case of some patterns. When thread is rolled in even after performing adjustment of (1) or (2), use the sewing machine with thread clamp OFF.
2. Thread clamp failure may occur in the state that thread waste is jammed in the thread clamp device. Remove the thread waste referring to "[III-1-6. Needle thread clamp device](#)" p.106.

### 5-3. Adjusting the intermediate stop position of the feeding frame (left) (For the separately-driven feeding frame with a double-stepped stroke function)



#### WARNING :

Turn OFF the power before starting the work so as to prevent accidents caused by abrupt start of the sewing machine.

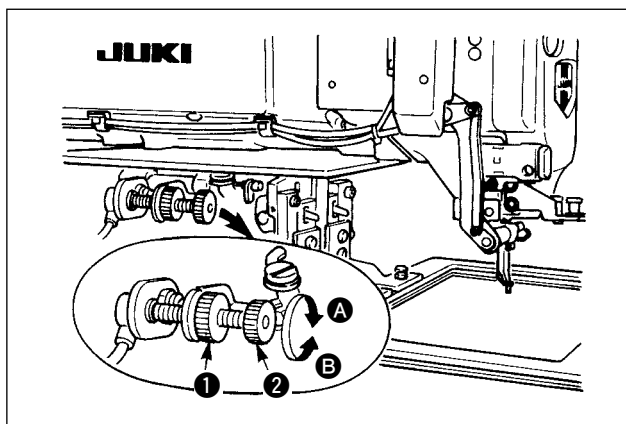

- 1) Loosen knob ❶.
- 2) Adjust the intermediate stop position of the feeding frame by turning knob ❷ so that it stops slightly above the sewing product on the machine.

Turning knob ❷ in direction A will increase the height of the feeding frame in its intermediate stop position or in direction B will decrease it.

- 3) After the adjustment, securely tighten knob ❶.



Only the feeding frame (left) is capable of stopping in the intermediate stop position.

### 5-4. How to use the plastic blank (supplied with the machine as an accessory) (For the separately-feeding frame with a double-stepped stroke function)

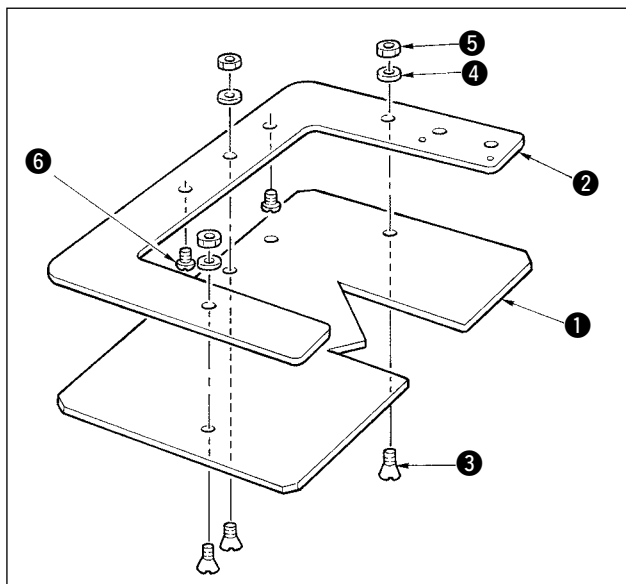

- 1) Machine the plastic blank supplied with the machine according to the stitching shape.
- 2) Attach the plastic blank to the feeding frame as illustrated in the figure shown above.





1. The plastic blank is commonly used with the frames (right) and (left) of the feeding frame. Attach the plastic blank to the frame (right).
2. Use a sponge sheet or rubber sheet supplied with the machine in combination with the plastic blank, if necessary.

❶	Plastic blank	40035093
❷	Feeding frame (left) for separately-driven feeding frame	40032844
❸	Setscrew	SM1041201SC
❹	Washer	WP0430801SC
❺	Nut	NM6040001SC
❻	Positioning screw	SM4040455SP

## II .OPERATION SECTION (WITH REGARD TO THE PANEL)

### 1. PREFACE

\* 3 kinds of service patterns are contained in the media of the accessories.

Kind Area	ENHS,ENHL (Vinyl leather)	ENHS,ENHL (Denim)	ENSS,ENSL
2516 3020	ø 60 Pitch 3.6mm Pattern No. 101 	ø 60 Pitch 3 mm Pattern No. 102 	ø 60 Pitch 2.5 mm Pattern No. 103 

#### 1) Kind of sewing data handled with IP-420

Pattern name	Description
Users' pattern	Pattern that can be stored in the body. Max. 999 patterns can be registered.
Vector format data	File that extension is ".VDT" Read from media. Max. 999 patterns can be used.
M3 data	Pattern data of AMS-D series Used by copying from floppy disk of AMS-D series to media. Max. 999 patterns can be used.
Sewing standard format	File that extension is ".DAT" Read from media. Max. 999 patterns can be used.

#### 2) Using the data (M3 data) of AMS-D series with AMS-221EN

There are two ways to use M3 data with AMS-221EN.

##### ① Reading by using IP-420

Use PC (personal computer) and copy file (¥AMS¥AMS00xxx.M3) of M3 from floppy disk of AMS-D to ¥AMS of media. Insert the media to IP-420, and select Pattern No.xxx from M3 data.

##### ② Changing to vector format data using PM-1

Change to the vector format data with PM-1. (For the details, refer to Help of PM-1.)

Copy the changed vector format data to ¥VDATA folder of the media.

Insert the media to IP-420 and select Pattern No.

### 3) Folder structure of the media

Store each file in the directories below of the media.

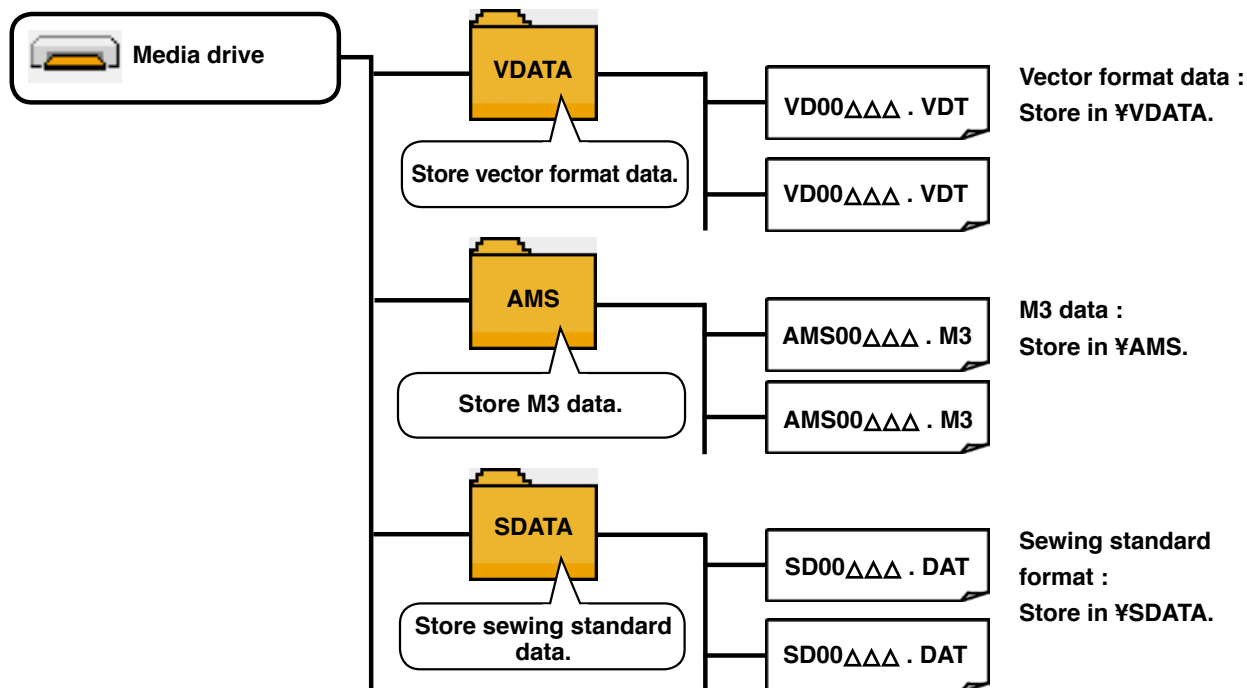

Data that are not stored in the directories above cannot be read. So, be careful.

### 4) CompactFlash (TM)

#### ■ Inserting the CompactFlash (TM)

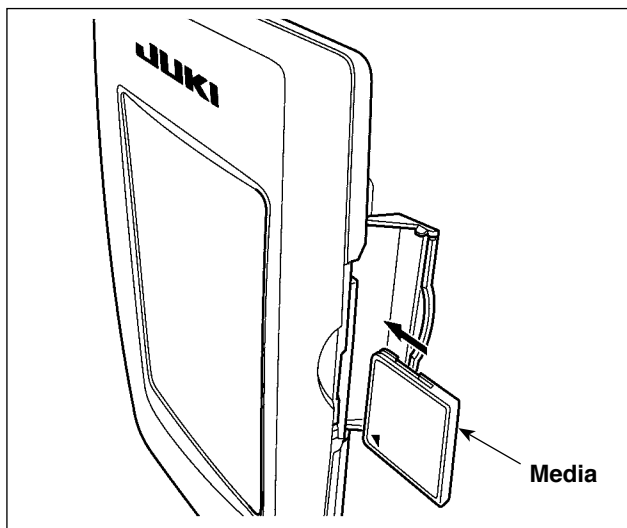

- 1) Turn the label side of the CompactFlash(TM) to this side (place the notch of the edge to the rear. ) and insert the part that has a small hole into the panel.
- 2) After completion of setting of the media, close the cover. By closing the cover, it is possible to access. If the media and the cover come in contact with each other and the cover is not closed, check the following matters.
  - Check that the media is securely pressed until it goes no further.
  - Check that the inserting direction of the media is proper.



1. When the inserting direction is wrong, panel or media may be damaged.
2. Do not insert any item other than the CompactFlash (TM).
3. The media slot in the IP-420 accommodates to the CompactFlash (TM) of 2 GB or less.
4. The media slot in the IP-420 supports the FAT16 which is the format of the Compact-Flash (TM). FAT32 is not supported.
5. Be sure to use the CompactFlash (TM) which is formatted with IP-420. For the formatting procedure of the CompactFlash (TM), see "[II-2-28. Performing formatting of the media](#)", p.81.

## ■ Removing the CompactFlash (TM)

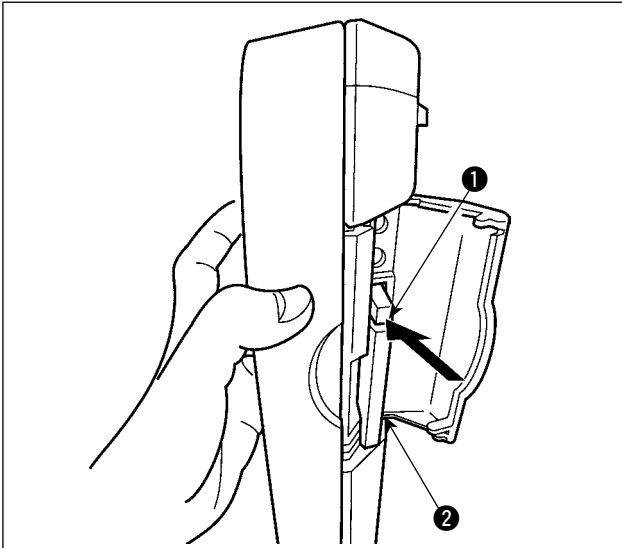

- 1) Hold the panel by hand, open the cover, and press the media ② removing lever ①. The media is eject.



When the lever ① is strongly pressed, the media ② may be broken by protruding and falling.

- 2) When the media ② is drawn out as it is, removing is completed.

## 5) USB port

### ■ Inserting a device into the USB port

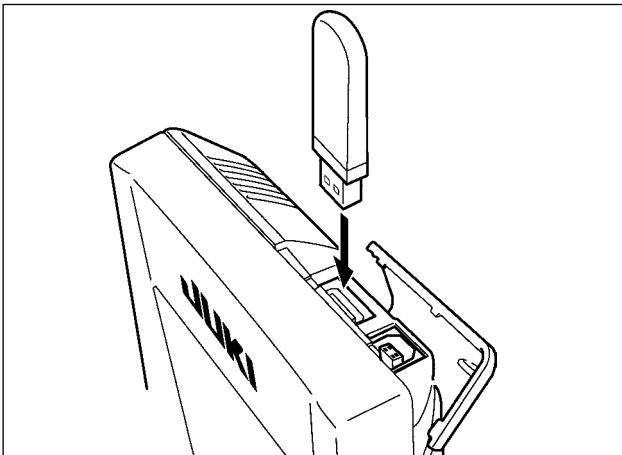

Slide the top cover and insert the USB device into the USB port. Then, copy data to be used from the USB device onto the main body.

After completion of copying the data, remove the USB device.

### ■ Disconnecting a device from the USB port

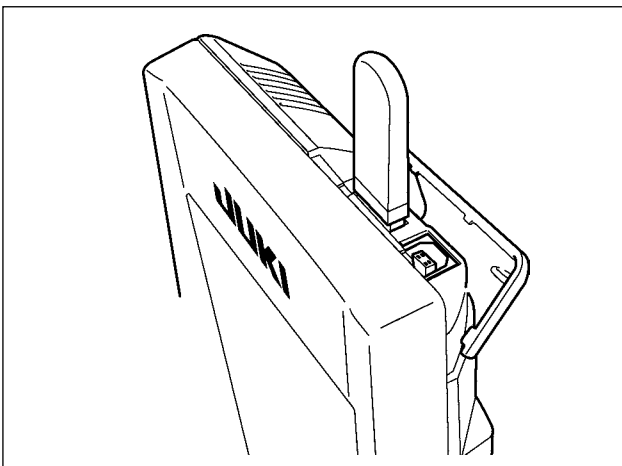

Remove the USB device. Put the cover back in place.

### Cautions when using the media



- Do not wet or touch it with wet hands. Fire or electric shock will be caused.
- Do not bend, or apply strong force or shock to it.
- Never perform disassembling or remodeling of it.
- Do not put the metal to the contact part of it. Data may be disappeared.
- Avoid storing or using it in the places below.

Place of high temperature or humidity / Place of dew condensation /

Place with much dust / Place where static electricity or electrical noise is likely to occur





- ① Precautions to be taken when handling USB devices
- Do not leave the USB device or USB cable connected to the USB port while the sewing machine is in operation. The machine vibration can damage the port section resulting in loss of data stored on the USB device or breakage of the USB device or sewing machine.
  - Do not insert/remove a USB device during reading/writing a program or sewing data. It may cause data breakage or malfunction.
  - When the storage space of a USB device is partitioned, only one partition is accessible.
  - Some type of the USB device may not be properly recognized by this sewing machine.
  - JUKI does not compensate for loss of data stored on the USB device caused by using it with this sewing machine.
  - When the panel displays the communication screen or pattern data list, the USB drive is not recognized even if you insert a medium into the slot.
  - For USB devices and media such as CF cards, only one device/medium should be basically connected/inserted to/into the sewing machine. When two or more devices/media are connected/inserted, the machine will only recognize one of them. Refer to the USB specifications.
- ② USB specifications
- Conform to USB 1.1 standard
  - Applicable devices \*1 \_\_\_ Storage devices such as USB memory, USB hub, FDD and card reader
  - Not-applicable devices \_\_\_ CD drive, DVD drive, MO drive, tape drive, etc.
  - Format supported \_\_\_ FD (floppy disk) FAT 12  
Others (USB memory, etc.), FAT 12, FAT 16, FAT 32
  - Applicable medium size \_ FD (floppy disk) 1.44MB, 720kB  
Others (USB memory, etc.), 4.1MB ~ (2TB)
  - Recognition of drives \_\_\_ For external devices such as a USB device, the device which is recognized first is accessed. However, when a medium is connected to the built-in media slot, the access to that medium will be given the highest priority. (Example: If a medium is inserted into the media slot even when the USB memory has already been connected to the USB port, the medium will be accessed.)
  - Restriction on connection \_ Max. 10 devices (When the number of storage devices connected to the sewing machine has exceeded the maximum number, the 11th storage device and beyond will not be recognized unless they are once disconnected and re-connected. )
  - Consumption current \_\_\_ The rated consumption current of the applicable USB devices is 500 mA at the maximum.
- \*1: JUKI does not guarantee operation of all applicable devices. Some device may not operate due to a compatibility problem.

## 2. WHEN USING IP-420

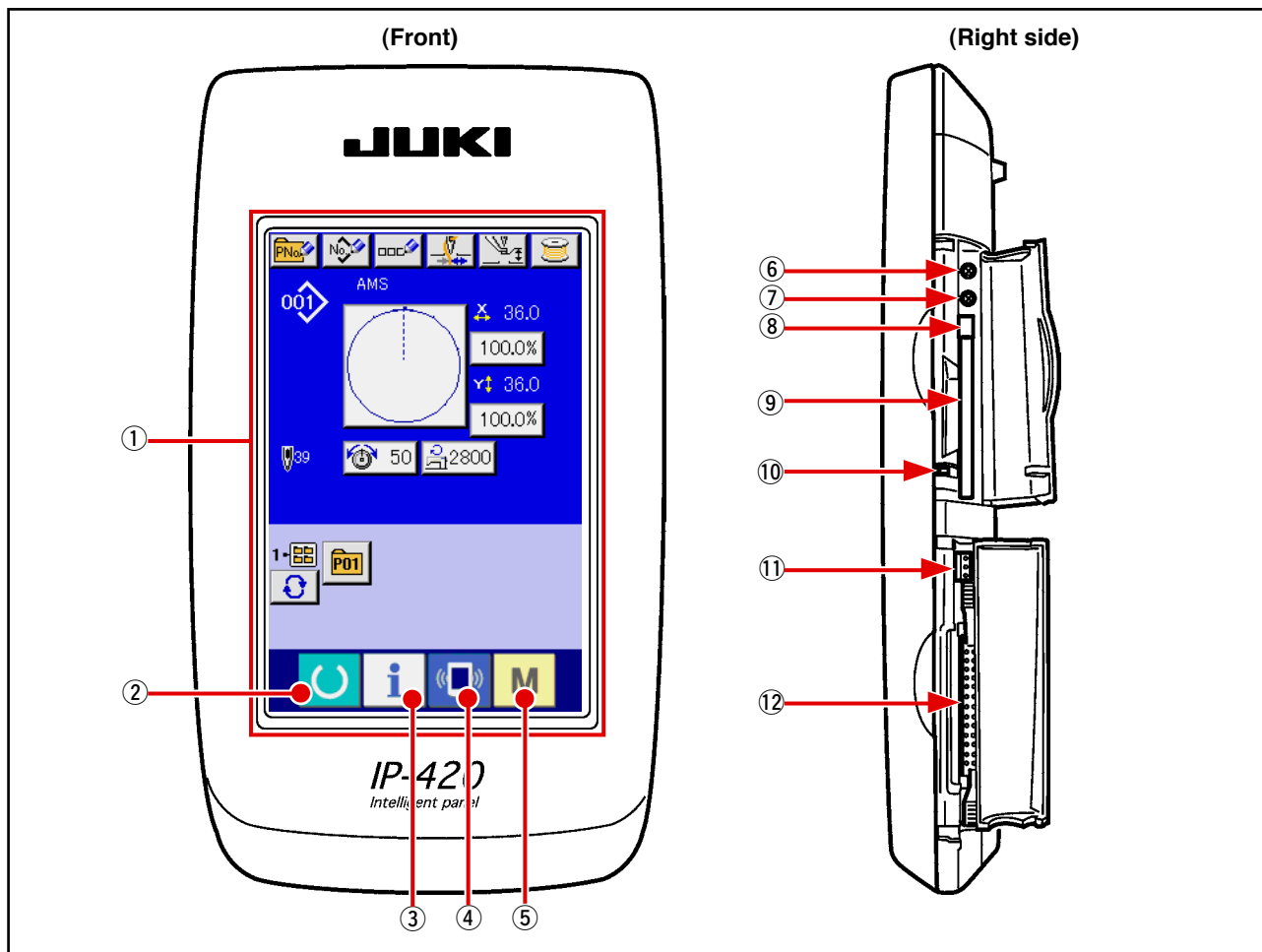
### 2-1. Name of each section of IP-420



① Touch panel · LCD display section

- ②  READY key → Changeover of the data input screen and the sewing screen can be performed.
- ③  INFORMATION key → Changeover of the data input screen and the information screen can be performed.
- ④  COMMUNICATION key → Changeover of the data input screen and the communication screen can be performed.

⑤  MODE key → Changeover of the data input screen and the mode changeover screen which performs various detail settings can be performed.

- ⑥ Contrast control
- ⑦ Brightness control
- ⑧ CompactFlash (TM) eject button
- ⑨ CompactFlash (TM) slot
- ⑩ Cover detection switch
- ⑪ Connector for external switch
- ⑫ Connector for control-box connection

## 2-2. Buttons to be used in common

The buttons which perform common operations in each screen of IP-420 are as follows :



CANCEL button

→ This button closes the pop-up screen.  
In case of the data change screen, the data being changed can be cancelled.



ENTER button

→ This button determines the changed data.



UP SCROLL button

→ This button scrolls the button or the display in the upward direction.



DOWN SCROLL button

→ This button scrolls the button or the display in the downward direction.



RESET button

→ This button performs the release of error.



NUMERAL INPUT button

→ This button displays ten keys and input of numerals can be performed.



CHARACTER INPUT button

→ This button displays the character input screen.  
→ Refer to “[II-2-14. Naming users' pattern](#)” p.45.



RESSER LOWERING button

→ Presser is lowered, and the presser lowering screen is displayed. To lift presser, press presser lift button displayed in the presser lowering screen.



Bobbin winder button

→ Bobbin thread winding is performed.  
→ Refer to “[II-2-11. Winding bobbin thread](#)” p.40.



## 2-3. Basic operation of IP-420



### ① Turn ON the power switch

When the power is turned ON first, the language selection screen is displayed. Set the language you use. (It is possible to change with Memory switch U500.)



When ending the selection screen with **CANCEL** button  or **ENTER** button  without performing the language selection, the language selection screen is displayed whenever the power is turned ON.

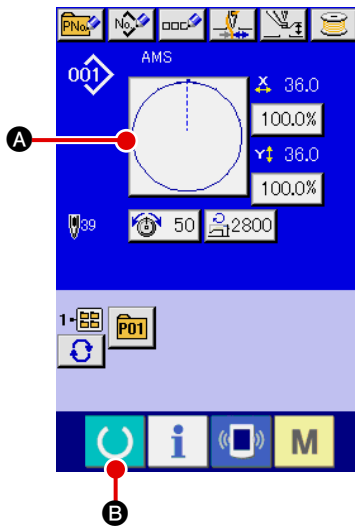

### ② Select the pattern No. you desire to sew.

When the power is turned ON, the data input screen is displayed. Pattern No. button **A** which is selected at present is displayed in the center of the screen. Press the button to select the sewing shape. For selecting procedure of the sewing shape, refer to "[II-2-5. Performing sewing shape selection](#)" p.30.

When **READY** key  **B** is pressed, the back color of LCD display is changed to green, and the sewing machine is set to the sewing possible state.

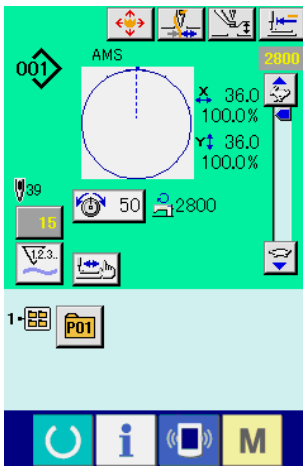

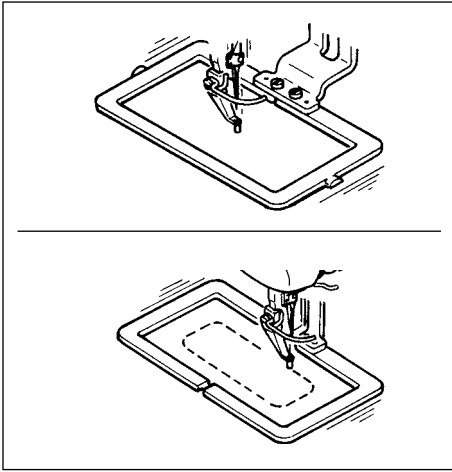

③ **Start sewing.**

Start sewing referring to "[I-5-1. Sewing](#)" p.14.

- \* For the screen, refer to "[II-2-4. LCD display section at the time of sewing shape selection](#)" p.26.







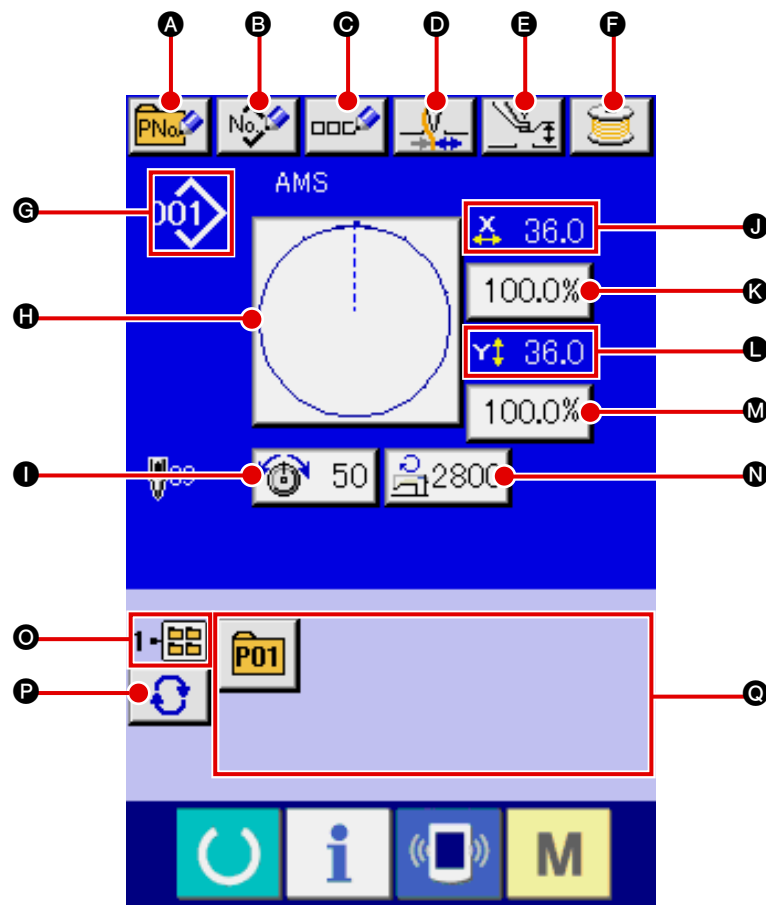

1. When using the exclusive presser, confirm the pattern shape for safety's sake. Should the pattern protrude from the feeding frame, needle interferes with the feeding frame during sewing, and there is a danger of needle breakage or the like.
2. When the presser is going up, be careful that your fingers are caught with the presser since the presser moves after coming down.
3. When turning OFF the power without pressing READY key , the set value of "Pattern No.", "X enlargement/reduction ratio", "Y enlargement/reduction ratio", "Max. sewing speed", "Thread tension" or "Intermediate presser height" is not stored in memory.

## 2-4. LCD display section at the time of sewing shape selection

### (1) Sewing shape data input screen





	Button and display	Description
A	PATTERN BUTTON NEW REGISTER button	Pattern button new register screen is displayed. → Refer to “ <a href="#">II-2-15. Performing new register of pattern button</a> ” p.46.
B	USERS' PATTERN NEW REGISTER button	Users' pattern new register screen is displayed. → Refer to “ <a href="#">II-2-13. Performing new register of users' pattern</a> ” p.44.
C	PATTERN BUTTON NAME SETTING button	Pattern button name input screen is displayed. → Refer to “ <a href="#">II-2-14. Naming users' pattern</a> ” p.45.
D	THREAD CLAMP button	Effective/ineffective of thread clamp is selected.  : Thread clamp ineffective  : Thread clamp effective
E	INTERMEDIATE PRESSER SETTING button	Intermediate presser is lowered and the intermediate presser reference value change screen is displayed. → Refer to “ <a href="#">II-2-6. Changing item data</a> ” p.32.
F	BOBBIN WINDER button	Bobbin thread can be wound. → Refer to “ <a href="#">II-2-11. Winding bobbin thread</a> ” p.40.



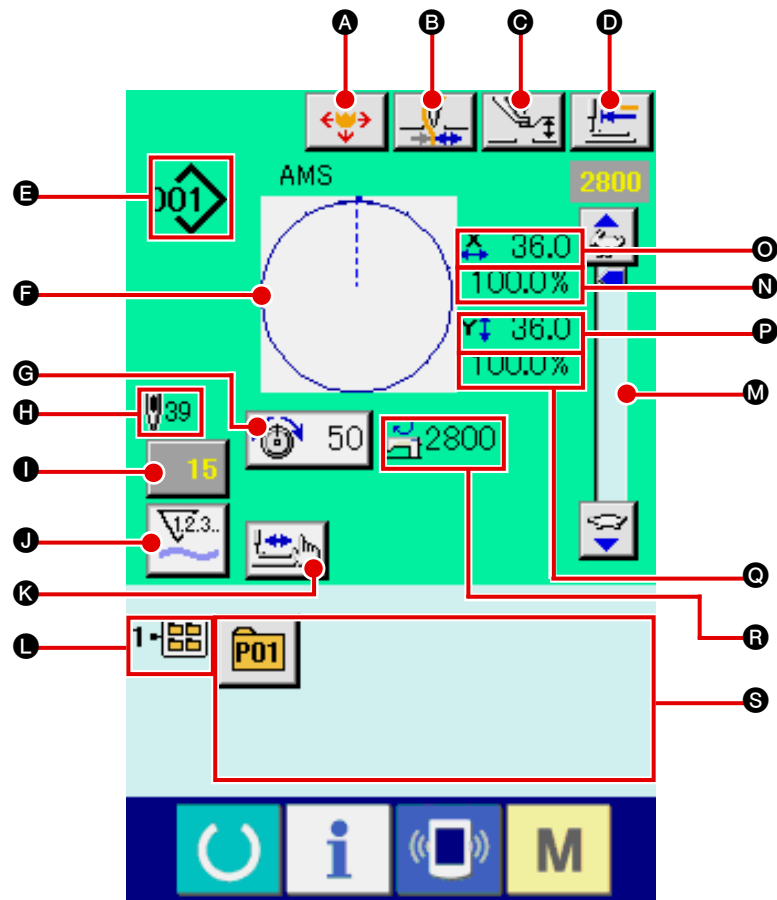

	Button and display	Description
Ⓒ	SEWING SHAPE NO. display	<p>Kind and No. of the sewing shape being selected at present is displayed. There are 4 kinds below of the kinds of sewing shape.</p> <p> : Users' pattern</p> <p> : Vector format data</p> <p> : M3 data</p> <p> : Sewing standard format</p> <p>* Be sure to use the media that has been formatted with IP-420. For the formatting procedure of the media, refer to "<a href="#">II-2-28. Performing formatting of the media</a>" p.81.</p>
Ⓓ	SEWING SHAPE SELECTION button	<p>Sewing shape being selected at present is displayed on this button and when the button is pressed, the sewing shape selection screen is displayed.</p> <p>→ Refer to "<a href="#">II-2-5. Performing sewing shape selection</a>" p.30.</p>
Ⓔ	NEEDLE THREAD TENSION SETTING button	<p>Needle thread tension value which is set to the pattern data being selected at present is displayed on this button and when the button is pressed, the item data change screen is displayed.</p> <p>→ Refer to "<a href="#">II-2-6. Changing item data</a>" p.32.</p>
Ⓚ	X ACTUAL SIZE VALUE display	<p>Actual size value in X direction of sewing shape being selected at present is displayed.</p> <p>When the actual size value input is selected by setting memory switch <a href="#">U064</a>, X actual size value setting button is displayed.</p> <p>→ Refer to "<a href="#">II-2-6. Changing item data</a>" p.32.</p>
Ⓚ	X SCALE RATE SETTING button	<p>Scale rate in X direction of sewing shape being selected at present is displayed on this button.</p> <p>When the scale input is set to non-selection by setting memory switch <a href="#">U064</a>, the button goes out and the X scale is displayed.</p> <p>→ Refer to "<a href="#">II-2-6. Changing item data</a>" p.32.</p>
Ⓛ	Y ACTUAL SIZE VALUE display	<p>Actual size value in Y direction of sewing shape being selected at present is displayed.</p> <p>When the actual size value input is selected by setting memory switch <a href="#">U064</a>, Y actual size value setting button is displayed.</p> <p>→ Refer to "<a href="#">II-2-6. Changing item data</a>" p.32.</p>
Ⓜ	Y SCALE RATE SETTING button	<p>Scale rate in Y direction of sewing shape being selected at present is displayed on this button. When the scale input is set to non-selection by setting memory switch <a href="#">U064</a>, the button goes out and the Y scale is displayed. → Refer to "<a href="#">II-2-6. Changing item data</a>" p.32.</p>
Ⓝ	MAX. SPEED LIMITATION	<p>Maximum speed limitation which is set at present is displayed on this button and when the button is pressed, the item data change screen is displayed. (However, maximum speed limitation which is displayed is different from the maximum number of revolutions in the pattern.)</p> <p>→ Refer to "<a href="#">II-2-6. Changing item data</a>" p.32.</p>
Ⓖ	FOLDER NO. display	<p>Pattern register button which is displayed indicates the folder No. which has been stored.</p>
Ⓟ	FOLDER SELECTION button	<p>Folders to display the patterns are displayed in order.</p>
Ⓒ	PATTERN REGISTER button	<p>PATTERN REGISTER buttons stored in <b>Ⓖ</b> FOLDER NO display are displayed.</p> <p>→ Refer to "<a href="#">II-2-15. Performing new register of pattern button</a>" p.46.</p> <p>* This button is not displayed unless the new register to the pattern button is performed.</p>

## (2) Sewing screen



	Button and display	Description
<b>A</b>	PATTERN BUTTON MOVE button	The pattern button move screen is displayed. → Refer to “ <a href="#">II-2-10. When setting of sewing product is difficult because of interruption of needle tip</a> ” p.39.
<b>B</b>	THREAD CLAMP button	Effective/ineffective of the thread clamp is selected.  : Thread clamp ineffective  : Thread clamp effective
<b>C</b>	INTERMEDIATE PRESSER SETTING button	Intermediate presser is lowered and the intermediate presser reference value change screen is displayed. → Refer to “ <a href="#">II-2-6. Changing item data</a> ” p.32.
<b>D</b>	RETURN TO ORIGIN button	This button returns the presser to the start of sewing and raises the presser at the time of temporary stop.



	Button and display	Description
Ⓔ	SEWING SHAPE NO. display	<p>Kind and No. of the sewing shape being selected at present is displayed. There are 4 kinds below of the kinds of sewing shape.</p> <p> : Users' pattern</p> <p> : Vector format data</p> <p> : M3 data</p> <p> : Sewing standard format</p> <p>* Be sure to use the media that has been formatted with IP-420. For the formatting procedure of the media, refer to "<a href="#">II-2-28. Performing formatting of the media</a>" p.81.</p>
Ⓕ	SEWING SHAPE display	Sewing shape being selected at present is displayed.
Ⓖ	NEEDLE THREAD TENSION SETTING button	<p>Needle thread tension value which is set to the pattern data being selected at present is displayed on this button and when the button is pressed, the item data change screen is displayed.</p> <p>→ Refer to "<a href="#">II-2-6. Changing item data</a>" p.32.</p>
Ⓕ	TOTAL NUMBER OF STITCHES OF SEWING SHAPE display	Total number of stitches of the sewing shape being selected at present is displayed.
Ⓖ	COUNTER VALUE CHANGE button	<p>Existing counter value is displayed on this button.</p> <p>When the button is pressed, the counter value change screen is displayed.</p> <p>→ Refer to "<a href="#">II-2-12. Using counter</a>" p.41.</p>
Ⓖ	COUNTER CHANGE OVER button	<p>The counter display can be changed over among the sewing counter, No. of pcs. counter and bobbin counter.</p> <p>→ Refer to "<a href="#">II-2-12. Using counter</a>" p.41.</p>
Ⓖ	STEP SEWING button	<p>Step sewing screen is displayed. Checking of the pattern shape can be performed.</p> <p>→ Refer "<a href="#">II-2-7. Checking pattern shape</a>" p.34.</p>
Ⓖ	FOLDER NO. display	Pattern register button which is displayed indicates the folder No. which has been stored.
Ⓖ	SPEED variable resistor	Number of rotations of the sewing machine can be changed.
Ⓖ	X SCALE RATE display	Scale rate in X direction of sewing shape being selected is displayed.
Ⓖ	X ACTUAL SIZE VALUE display	Actual size value in X direction of sewing shape being selected is displayed.
Ⓖ	Y ACTUAL SIZE VALUE display	Actual size value in Y direction of sewing shape being selected is displayed.
Ⓖ	Y SCALE RATE display	Scale rate in Y direction of sewing shape being selected is displayed.
Ⓖ	MAX. SPEED LIMITATION display	Maximum speed limitation which is set at present is displayed. However, the display is different from the maximum number of revolutions in the pattern. However, the display is different from the maximum number of revolutions in the pattern.
Ⓖ	PATTERN REGISTER button	<p>Pattern register buttons stored in Ⓖ FOLDER NO. display are displayed.</p> <p>→ Refer to "<a href="#">II-2-15. Performing new register of pattern button</a>" p.46.</p> <p>* This button is not displayed in the initial state.</p>

## 2-5. Performing sewing shape selection

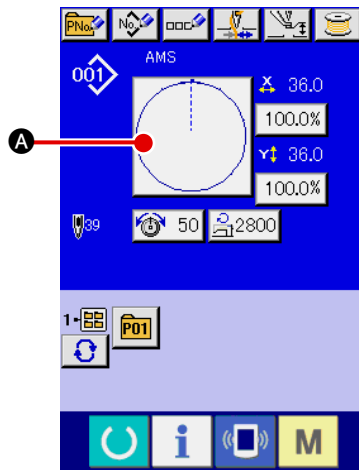

① **Display the data input screen.**

Only in case of the data input screen (blue), the selection of sewing shape can be performed. In case of the sewing screen (green), press READY key  and display the data input screen (blue).

② **Call the sewing shape selection screen.**

Press SEWING SHAPE button **A** and the sewing shape selection screen is displayed.

③ **Select the sewing shape.**

There are 4 kinds of the sewing shape.

Press SEWING SHAPE SELECTION button  **B**.

\* This button is not displayed in the initial state.

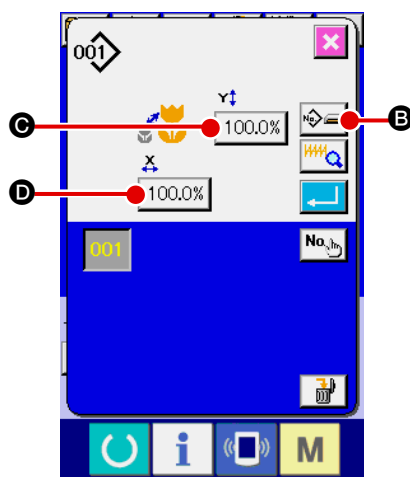



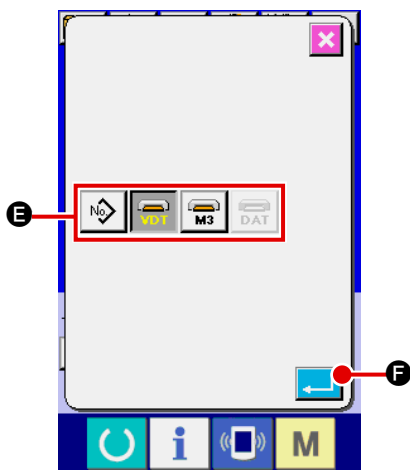

When button **C** or **D**  is pressed in this screen, X or Y enlarging/reducing ratio can be changed. For the details, refer to "[II-2-6. Changing item data](#)" p.32.

④ **Determine the kind of sewing shape.**

There are 4 kinds below of the sewing shape. Select the kind you desire from among them.



Pictograph	Name	Maximum number of patterns
	Users' pattern	999
	Vector format data	999
	M3 data	999
	Sewing standard format	999



**Be sure to use the media that has been formatted with IP-420.**  
For the formatting procedure of the media, refer to "[II-2-28. Performing formatting of the media](#)" p. 81.

Select the sewing shape you desire from SEWING SHAPE SELECTION buttons **E** and press ENTER  **F** button.

The sewing shape list screen corresponding to the kind of sewing shape you selected is displayed.

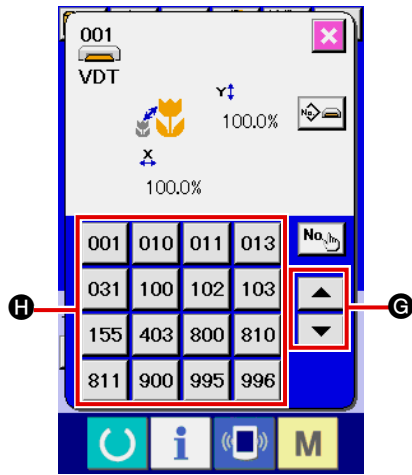

⑤ **Select the sewing shape.**

When UP or DOWN SCROLL button  **G** is pressed, the SEWING SHAPE buttons **H** are changed over in order.

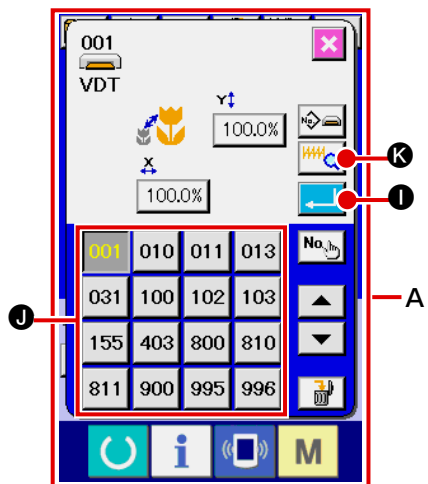

⑥ **Determine the sewing shape.**

When ENTER button  **I** is pressed, the sewing shape is determined and the data input screen is displayed.

When the sewing shape is users' pattern, the screen as **A** is displayed.

PATTERN NO. SELECTION button **J** that is registered to users' pattern is displayed. Press the button of PATTERN NO. you desire to select.

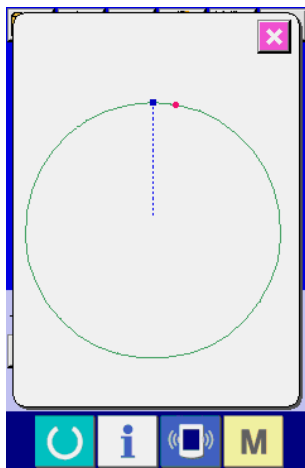

When VIEWER button  **K** is pressed, the shape of the pattern No. selected is displayed and you can confirm it.

## 2-6. Changing item data



### WARNING :

Be sure to confirm the shape of pattern after the change of X/Y enlargement/reduction ratio. There may be a dangerous case such as needle breakage by interference of needle with the presser or the like according to the set value.

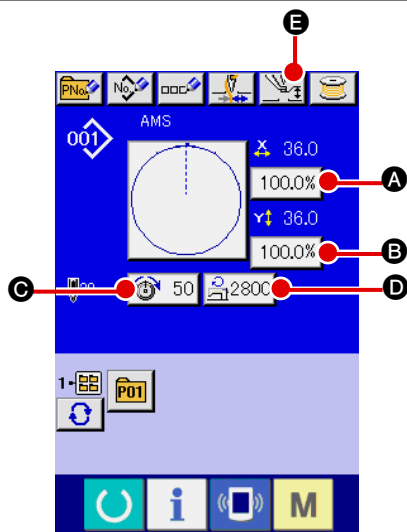

#### ① Display the data input screen.

In case of the data input screen, the change of item data can be changed. In case of the sewing screen (green), press READY switch to display the data input screen (blue).

- \* **The thread tension and the intermediate presser height can be changed even on the sewing screen.**

#### ② Display the item data input screen.

When the button of the item data you desire to change is pressed, the item data input screen is displayed. Item data are 5 items below.

	Item range	Input range	Initial value
<b>A</b>	Scale rate in X direction	1.0 to 400.0 (%)	100.0 (%)
<b>B</b>	Scale rate in Y direction	1.0 to 400.0 (%)	100.0 (%)
<b>C</b>	Thread tension	0 to 200	Pattern set value
<b>D</b>	Max. speed limitation	200 to 2,800 (sti/min)	2,800 (sti/min)
<b>E</b>	Intermediate presser height	0.0 to 3.5 (mm) (Max 0.0 to 7.0 (mm))	Pattern set value

- \* Thread tension value and intermediate presser reference value will change with every pattern to be selected.
- \* **A** Scale rate in X direction and **B** Scale rate in Y direction can be changed to actual size value input by selection of the memory switch **U064**.
- \* There are two ways below to perform X/Y enlargement/reduction.
  - The data already read in this data input screen can be repeatedly enlarged or reduced.
  - X/Y scale rate can be set and read when selecting the pattern. See "**II-2-5. Performing sewing shape selection**" p.30.
- \* In case of the point sewing, even when increase/decrease of number of stitches is set under **U088** Enlargement and reduction function mode, enlargement and reduction can be performed with increase/decrease of pitch.
- \* When X/Y scale rate is individually set in case of circle or arc, or X/Y enlargement and reduction are repeated, the sewing is changed to point sewing and the shape may not be kept. Enlargement and reduction can be performed by increase/decrease of pitch. In this case, set and read X/Y scale rate in the pattern list screen.
- \* Max. input range and initial value of max. speed limitation **D** are determined with memory switch **U001**.
- \* Change of the intermediate presser height cannot be performed immediately after turning ON the power or immediately after moving from the main unit input. Use the machine after pressing READY key and performing the origin retrieval.

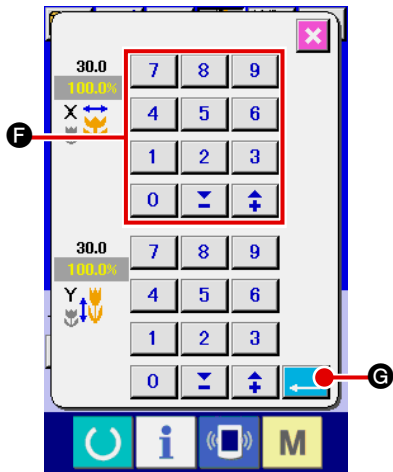

For example, input X scale rate.

Press  **A** to display the item data input screen.

③ **Input the data.**

Input the value you desire with ten keys and + / – keys **F**.

④ **Determine the data.**

When ENTER button  **G** is pressed, the data is determined.

\* For the other item data, the data can be changed by the same operation.

\* It is possible to input X/Y value of enlargement/reduction ratio and actual size value with one screen.

1. When turning OFF the power without pressing READY key , the set value of "Pattern No.", "X enlargement/reduction ratio", "Y enlargement/reduction ratio", "Max. sewing speed", "Thread tension" or "Intermediate presser height" is not stored in memory.
2. When operation processing cannot be performed since the reduction ratio is excessively small, E045 Pattern data error is displayed.
3. When the scale rate is changed with increase/decrease of number of stitches (pitch is fixed), mechanical control command inputted to the points other than the shape point is deleted.

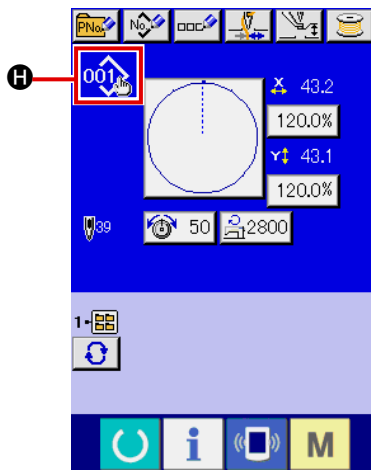

When X/Y enlargement/reduction ratio, thread tension, intermediate presser, adding/deleting of thread tension command, or adding/deleting of increase/decrease value of intermediate presser of users' pattern or media pattern is performed, the pattern kind section becomes change display **H**.

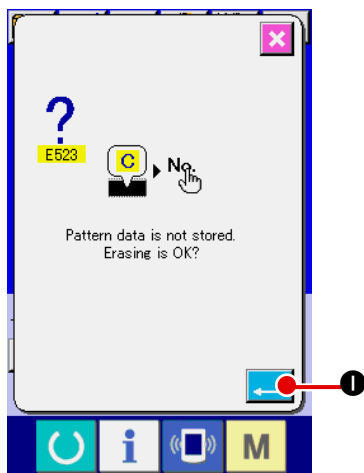

In case of change display **H**, the change confirmation screen is displayed at the time of the change of pattern.

When ENTER button  **I** is pressed, the information on the current pattern is invalidated and the pattern No. is changed.

To store the changed pattern, refer to **"II-2-13. Performing new register of users' pattern" p.44.**

## 2-7. Checking pattern shape



### WARNING :

Make sure without fail of the contour of the sewing pattern after selection of the sewing pattern. If the sewing pattern extends outside the work clamp feet, the needle will interfere with the work clamp.

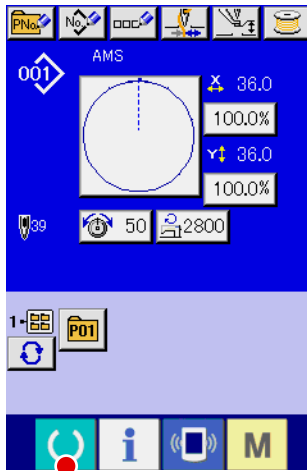

A

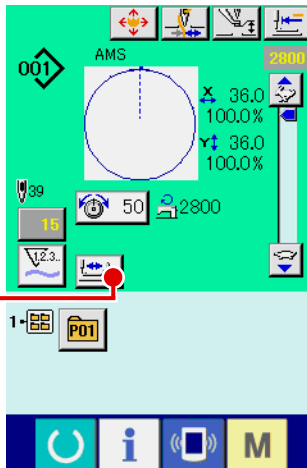

B

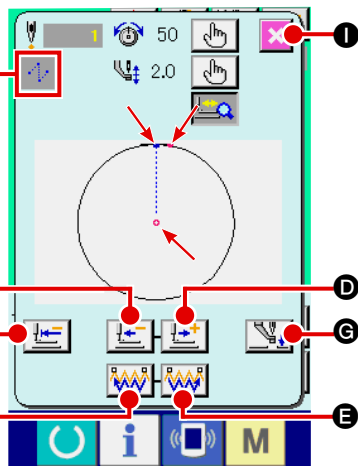

A

C

H

F

### ① Display the sewing screen.

Display the data input screen (blue) and press READY key



A.

Then the back-light of LCD changes to green and

sewing is possible. When the work clamp is in its upper position, the work clamp first comes down to its lower position and then moves to the sewing start point.



**Be careful not to get your fingers caught between the work clamp and the throat plate.**

### ② Display the step sewing screen.



When STEP SEWING button  B is pressed, the step sewing screen is displayed.



### ③ Lower the presser with the foot switch.





**The sewing machine does not start even when the foot switch is depressed with this mode.**

### ④ Proceed stitching with the presser lowered.

The sewing shape is displayed at the center of the screen. The current point, sewing start position and sewing end position are respectively represented by ,  and .



Check the sewing shape using ONE-STITCH BACKWARD button  C and ONE-STITCH FORWARD button  D. When two or more commands have been entered, the feed position does not change but the command display A is moved forward and backward. When you keep pressing the ONE-STITCH FORWARD or BACKWARD button, the moving speed increases.

When the COMMAND SEARCH FORWARD button  E is pressed, the feed automatically moves to the sewing end position. When the COMMAND SEARCH BACKWARD button  F is pressed, the feed automatically moves to the sewing start position.

To stop the feed, press button C, D, E, F, G or H.

When INTERMEDIATE PRESSER button  G is pressed, the intermediate presser is raised or lowered. (This button is not displayed when MEMORY switch U103 is set at 0 (zero).)

### ⑤ Finish checking the shape.

When PRESSER INITIAL POSITION button  H is pressed, the work clamp moves to the sewing start position and the screen is restored to the sewing screen. When CANCEL button  I is pressed, the screen is also restored to the sewing screen. When the work clamp does not rest at the sewing start or end position, sewing can be started by depressing the foot switch before sewing shape checking is not completed.



## 2-8. Performing modification of needle entry point

### (1) Editing the thread tension



Press STEP SEWING button  **A** on the sewing screen to display the step sewing screen.





When it is necessary to move the feed forward or backward such as in the case of needle checking, the feed does not move unless the work clamp is lowered. Be sure to check the needle or other relevant operation after having lowered the work clamp.

The sewing shape is displayed at the center of the screen. The current point, sewing start position and sewing end position are respectively represented by  (pink circle),  (blue dot) and  (pink dot).

Press the MODE SELECT button  **B** to select the thread tension mode.

When ONE-STITCH BACKWARD button  **C** or FORWARD button  **D** is pressed, the feed (current point ) moves backward or forward by one stitch. When two or more commands have been entered, the feed position does not change but the command display **A** is moved forward and backward. When you keep pressing the button **C** or **D**, the moving speed increases.

Indicated value **B** is the absolute value (Thread tension value + Thread tension command value).

When COMMAND SEARCH FORWARD button  **E** or BACKWARD button  **F** is pressed, the feed moves forward or backward from the current point to reach the needle entry point where the first thread tension command is found. To stop the feed, press button **C**, **D**, **E**, **F**, **G** or **H**.

When INTERMEDIATE PRESSER button  **G** is pressed, the intermediate presser is raised or lowered. (This button is not displayed when MEMORY switch U103 is set at 0 (zero).)

When PRESSER INITIAL POSITION button  **H** is pressed, the work clamp moves to its origin and the screen is restored to the sewing screen.

When COMMAND DELETE button  **I** is pressed, the screen for deleting the command as shown in **A** is displayed.

When  **J** is pressed, the thread tension value increase/decrease input screen is displayed.

Input a desired value on the thread tension value increase/decrease input screen using numeric keypad and +/- keys **K**.

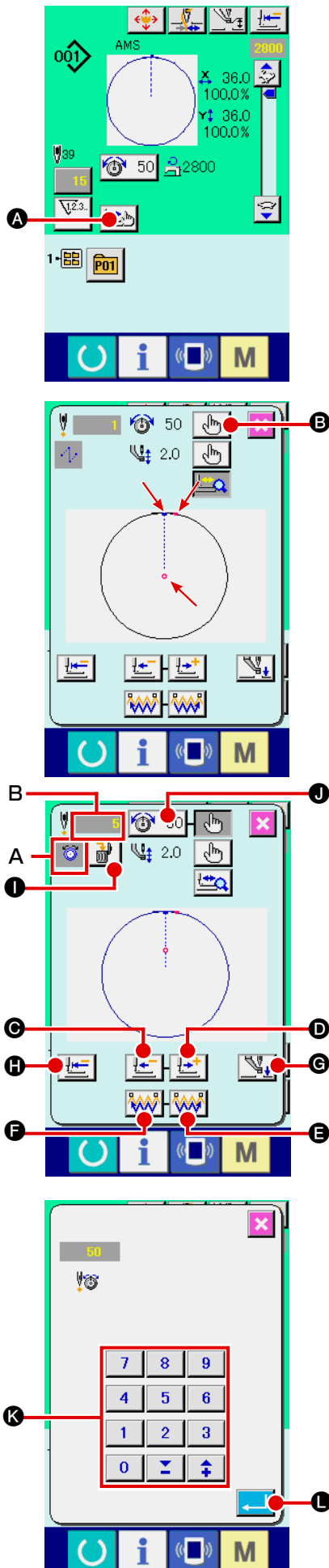

When ENTER button  **L** is pressed, the data is confirmed.

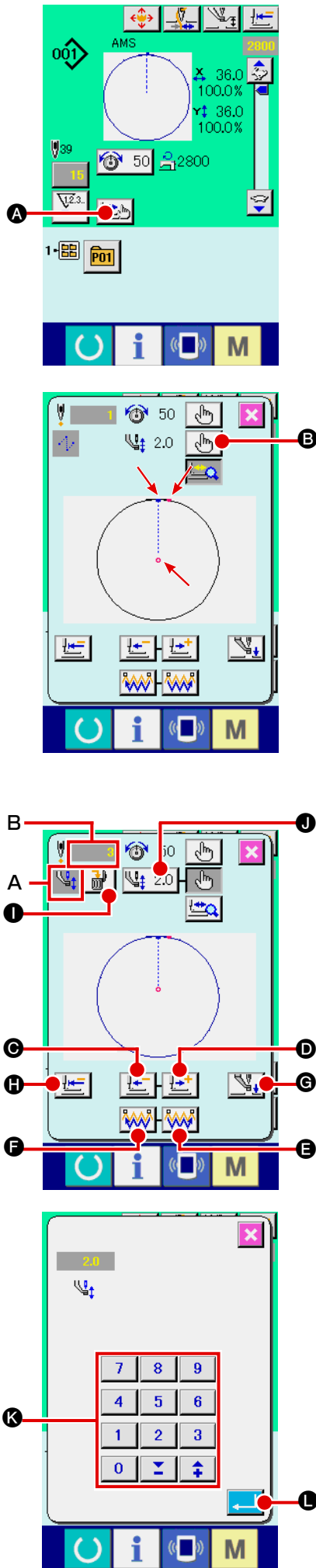







## (2) Editing the intermediate presser height



Press STEP SEWING button  **A** on the sewing screen to display the step sewing screen.

The sewing shape is displayed at the center of the screen. The current point, sewing start position and sewing end position are respectively represented by  (pink circle),  (blue dot) and  (pink dot).

Press MODE SELECT button  **B** to select the intermediate presser mode.

When ONE-STITCH BACKWARD button  **C** or FORWARD button  **D** is pressed, the feed (current point ) moves backward or forward by one stitch. When two or more commands have been entered, the feed position does not change but the command display **A** is moved forward and backward. When you keep pressing the button **C** or **D**, the moving speed increases.

Indicated value **B** is the absolute value (Intermediate presser height value + Intermediate presser height increased/decreased value).

When COMMAND SEARCH FORWARD button  **E** or BACKWARD button  **F** is pressed, the feed moves forward or backward from the current point to reach the needle entry point where the first intermediate presser command is found. To stop the feed, press button **C**, **D**, **E**, **F**, **G** or **H**.

When INTERMEDIATE PRESSER button  **I** is pressed, the intermediate presser is raised or lowered. (This button is not displayed when MEMORY switch U103 is set at 0 (zero).)

When PRESSER INITIAL POSITION button  **J** is pressed, the work clamp moves to its origin and the screen is restored to the sewing screen.

When COMMAND DELETE button  **K** is pressed, the screen for deleting the command as shown in **A** is displayed.

When  **L** is pressed, the intermediate presser height increase/decrease input screen is displayed. Input a desired value on this screen using numeric keypad and +/- keys **M**.

When ENTER button  **N** is pressed, the data is confirmed.

1. When checking the needle, or performing the feed forward or backward, the machine fails to work unless the presser is lowered. Use the machine after lowering the presser.
2. When the intermediate presser rests at its lower position, the movement of the intermediate presser and needle differ depending on the setting of MEMORY switch U103.
3. When increasing the height of intermediate presser or making the needle size thicker, confirm the clearance between the wiper and the components. Wiper cannot be used unless the clearance is secured. In this case, turn OFF the wiper switch, or change the set value of memory switch U105.



Refer to "**II-3. MEMORY SWITCH DATA LIST**" p.84 for the memory switch settings.



## 2-9. How to use temporary stop

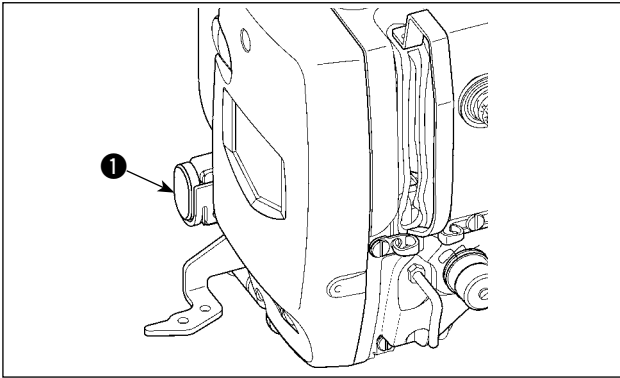

When TEMPORARY STOP switch ① is pressed during sewing, the sewing machine can be stopped. At this time, the error screen is displayed to inform that the stop switch has been pressed.

### (1) To continue performing sewing from some point in sewing

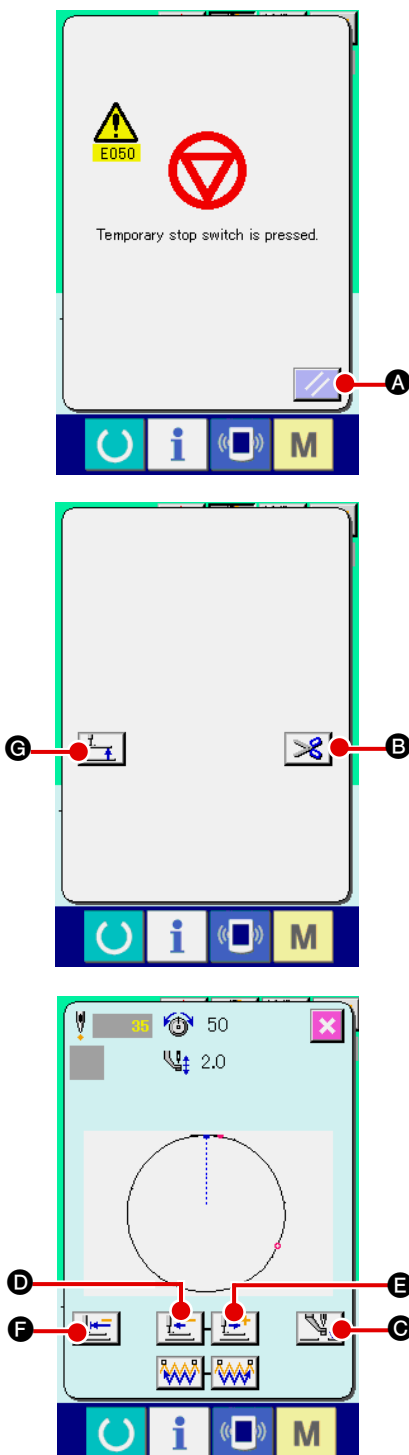





#### ① Release the error.

Press RESET button  A to release the error.

#### ② Perform thread trimming.

Press THREAD TRIM button  B to perform thread trimming.

When PRESSER UP button  G is pressed, the presser goes up. Turn OFF the power since the operation afterwards cannot be performed.

When thread trimming is performed, INTERMEDIATE PRESSER UP/DOWN button  C, FEED BACKWARD button  D, FEED FORWARD button  E, and RETURN TO ORIGIN button  F are displayed in the screen.



1. When the presser is raised and the operation is stopped on the way because of the trouble of forgetting to enter the bobbin case or the like, press

PRESSER UP button  G and turn OFF the power.

2. PRESSER UP button  G is not displayed when the presser is of pneumatic type.

#### ③ Adjust the presser to the re-sewing position.

When FEED BACK button  D is pressed, the presser

returns stitch by stitch and when FEED FORWARD button  E

is pressed, it advances stitch by stitch. Move the presser to the re-sewing position.

#### ④ Re-start the sewing

When the pedal is depressed, sewing starts again.

## (2) To perform re-sewing from the start

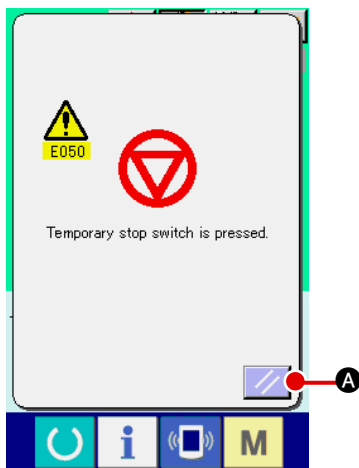





### ① Release the error.

Press RESET button  **A** to release the error.

### ② Perform thread trimming.



Press THREAD TRIM button  **B** to perform thread trimming.

When PRESSER UP button  **C** is pressed, the presser goes up. Turn OFF the power since the operation afterwards cannot be performed.

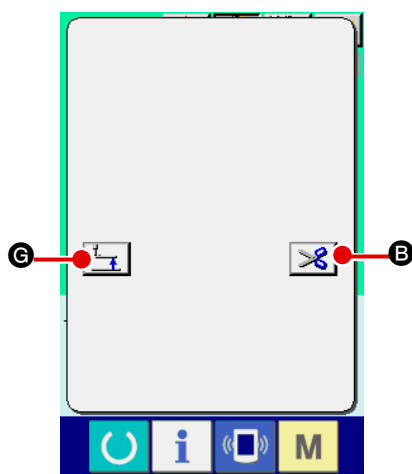
When thread trimming is performed, INTERMEDIATE PRESSER UP/DOWN button  **C**, FEED BACKWARD button  **D**, FEED FORWARD button  **E**, and RETURN TO ORIGIN button  **F** are displayed in the screen.



1. When the presser is raised and the operation is stopped on the way because of the trouble of forgetting to enter the bobbin case or the like, press

 PRESSER UP button  **C** and turn OFF the power.

2. PRESSER UP button  **C** is not displayed when the presser is of pneumatic type.

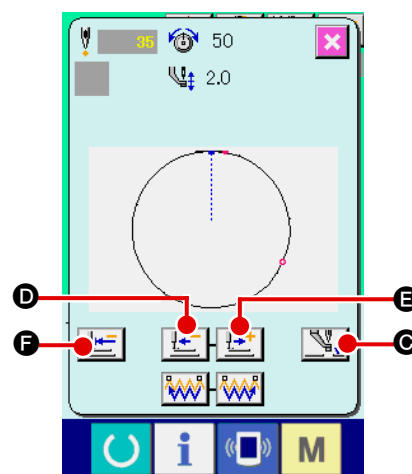

### ③ Return to the origin.

When RETURN TO ORIGIN button  **F** is pressed, the pop-up is closed, the sewing screen is displayed and the machine returns to the position of the start of sewing.

### ④ Perform again the sewing work from the start.

When the pedal is depressed, sewing starts again.

## 2-10. When setting of sewing product is difficult because of interruption of needle tip

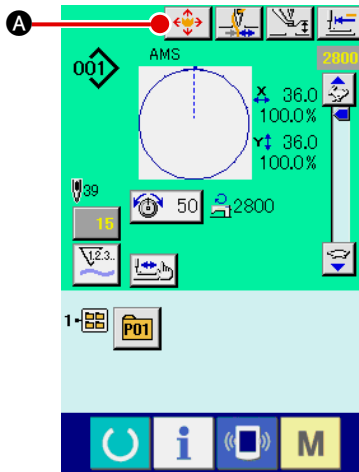

### ① Display the pattern button move screen.

When PATTERN BUTTON MOVE button  **A** is pressed, the pattern button move screen is displayed.

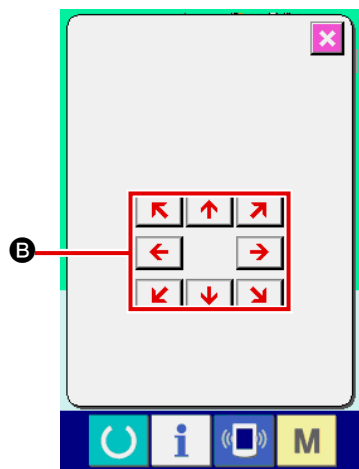

### ② Move the pattern.

Lower the presser, and input the move direction with DIRECTION key **B**.



The moving amount set can be effective only in the sewing screen.

When the screen returns to the input screen by pressing down READY key, the moving amount set is erased.

## 2-11. Winding bobbin thread

### (1) When performing winding bobbin thread while performing sewing

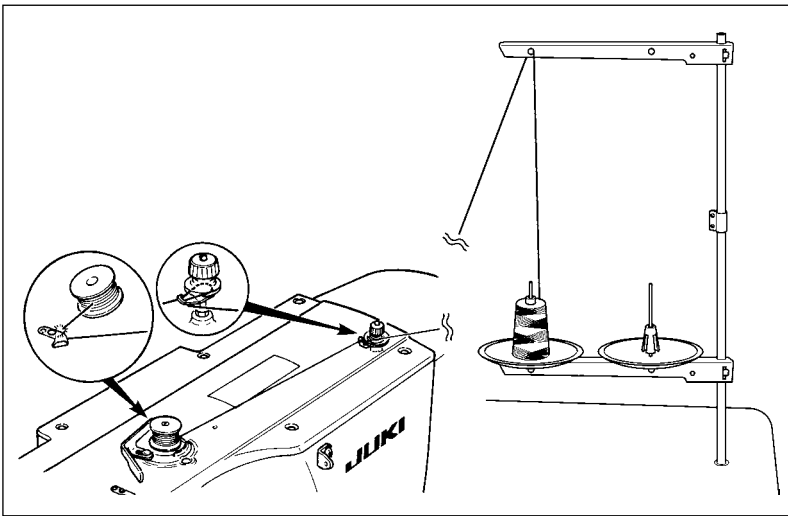

Thread the bobbin winder and wind the bobbin thread onto the bobbin as illustrated in the figure.

### (2) When performing winding bobbin thread only



#### ① Display the bobbin winding screen.

Press BOBBIN WINDER button  **A** in the data input screen (blue) and the presser comes down. Then the bobbin winding screen is displayed.

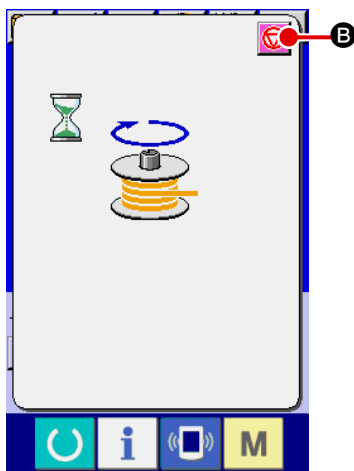

#### ② Start bobbin winding.

Depress the start pedal, and the sewing machine rotates and starts winding bobbin thread.

#### ③ Stop the sewing machine.

Press STOP button  **B** and the sewing machine stops and returns to the normal mode. Or, depress the start pedal again during winding bobbin and the sewing machine stops while the bobbin thread winding mode stays as it is. Depress the start pedal again and the bobbin winding starts again. Use this way when winding bobbin thread around plural bobbins.



Bobbin winder does not work immediately after turning ON the power. Perform the bobbin winding after setting pattern No. or the like once, pressing the READY key , and making the sewing LED light up.

## 2-12. Using counter

### (1) Setting procedure of the counter



#### ① Display the counter setting screen.

Press **M** switch and the COUNTER SETTING button .

**A** is displayed on the screen. When this button is pressed, the counter setting screen is displayed.

#### ② Selection of kinds of counters

This sewing machine has three different counters; i.e., the sewing counter, No. of pcs. counter and bobbin counter. When

SEWING COUNTER TYPE SELECT button  **B**, NO. OF

PCS. COUNTER TYPE SELECT button  **C** or BOBBIN

COUNTER TYPE SELECT button  **D** is pressed, the

corresponding counter type select screen is displayed. On this screen, the counter type can be selected individually.

#### [ Sewing counter ]

##### UP counter :



Every time the sewing of one shape is performed, the existing value is counted up. When the existing value is equal to the set value, the count-up screen is displayed.

##### DOWN counter :



Every time the sewing of one shape is performed, the existing value is counted down. When the existing value is reached to "0", the count-up screen is displayed.

##### Counter disuse:



The sewing counter does not count a finished shape even when the machine has sewn the shape. The counter screen of the sewing counter is not displayed.

#### [ No. of pcs. Counter ]

##### UP counter :



Every time one combination sewing is performed, the existing value is counted up. When the existing value is equal to the set value, the count-up screen is displayed.

##### DOWN counter :



Every time one combination sewing is performed, the existing value is counted down. When the existing value is reached to "0", the count-up screen is displayed.

##### Counter disuse:



The No. of pcs. counter does not perform counting. The counter screen of the No. of pcs. counter is not displayed.

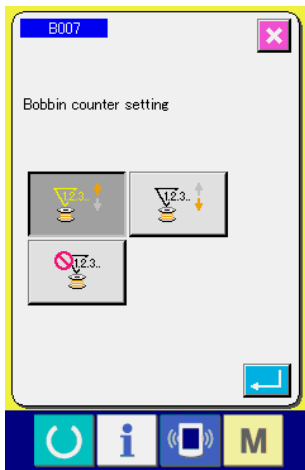

[ Bobbin counter ]	
	<b>UP counter :</b> The counter increases the existing value by one every time the machine has sewn 10 stitches. When the existing value is equal to the set value, the count-up screen is displayed.
	<b>DOWN counter :</b> The counter decreases from the existing value by one every time the machine has sewn 10 stitches. When the existing value is reached to "0", the count-up screen is displayed.
	<b>Counter disuse:</b> The bobbin counter does not perform counting. The counter screen of the bobbin counter is not displayed.

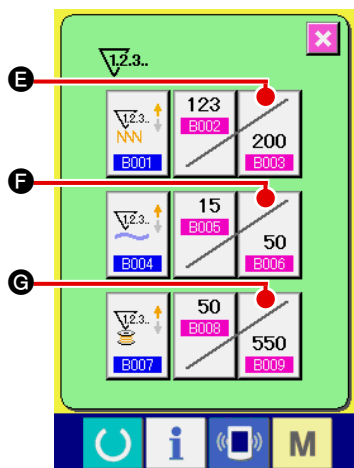

### ③ Change of counter set value

Press button **E** for the sewing counter, button **F** for the No. of pcs. counter or button **G** for the bobbin counter to display the corresponding counter set value input screen.

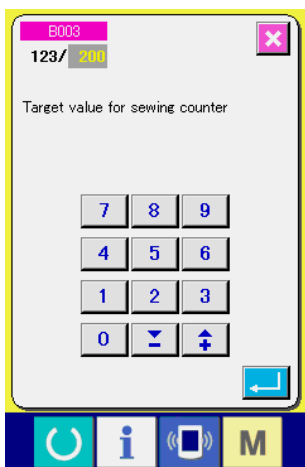

Here, input the set value.

When "0" is inputted in the set value, the display of count-up screen is not performed.

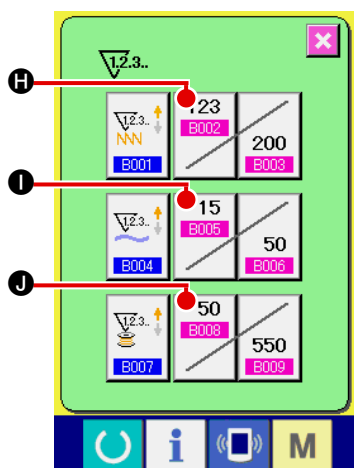

### ④ Change of counter existing value

Press button **H** for the sewing counter, button **I** for the No. of pcs. counter or button **J** for the bobbin counter to display the corresponding counter current value input screen.

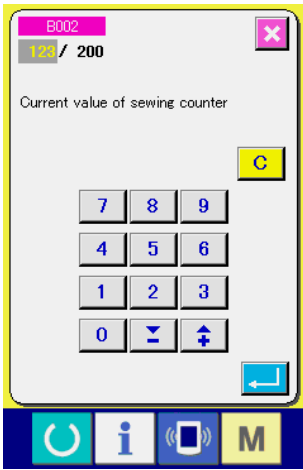

Here, input the existing value.

## (2) Count-up releasing procedure

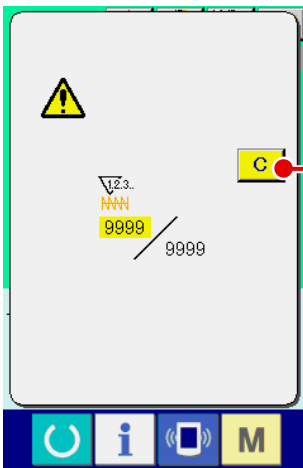

When the count-up condition is reached during sewing work, the count-up screen is displayed and the buzzer beeps. Press CLEAR button **C** **A** to reset the counter and the screen returns to the sewing screen. Then the counter starts counting again.

## (3) How to change the counter value during sewing

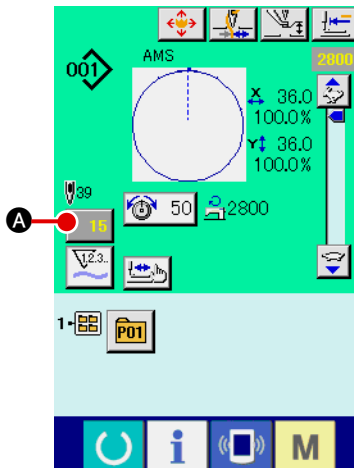

### ① Display the counter value change screen.

When you desire to revise the counter value during sewing work due to the mistake or the like, press COUNTER VALUE CHANGE button **15** **A** on the sewing screen. The counter value change screen is displayed.

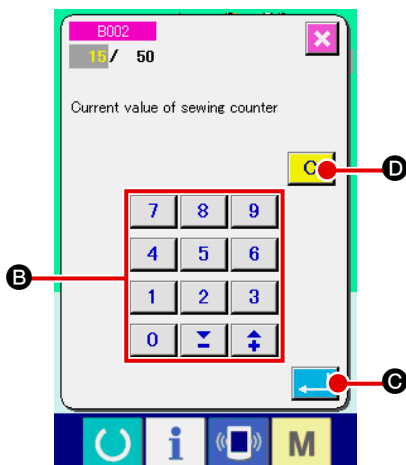

### ② Change the counter value.

Input the value you desire with ten keys, or “+” or “-” key **B**.

### ③ Determine the counter value.

When ENTER button **C** is pressed, the data is determined.

When you desire to clear the counter value, press CLEAR button **C** **D**.

## 2-13. Performing new register of users' pattern

### ① Display the data input screen.

Only in case of the data input screen (blue), new register of the pattern can be performed. In case of the sewing screen (green), press READY switch  and display the data input screen (blue).

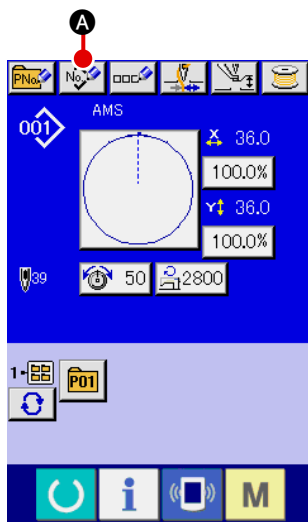

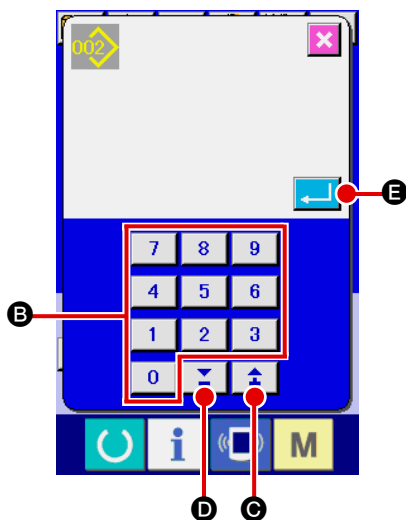

### ② Call the new register of users' pattern screen.

Press NEW REGISTER button  **A** and the new register of users' pattern screen is displayed.



### ③ Input the users' pattern No.

Input the users' pattern No. you desire to newly register with the ten keys **B**. It is possible to retrieve the users' pattern No. which has not been registered with the + or – button   (**C** and **D**).

### ④ Determine the users' pattern No.

Press ENTER button  **E** to determine the users' pattern NO. to be newly registered and the data input screen at the time of users' pattern selection is displayed. When the existing users' pattern No. is inputted and ENTER button is pressed, the overwriting confirmation screen is displayed.



## 2-14. Naming users' pattern

As many as 255 characters can be input for each user's pattern.

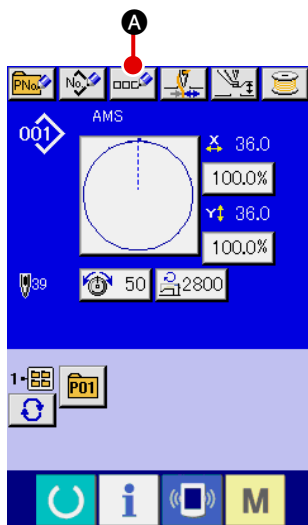

### ① Display the data input screen.

Only in case of the data input screen (blue) at the time of pattern button selection, it is possible to input the name of pattern button. In case of the sewing screen (green), press READY switch  to display the data input screen (blue).

### ② Call the character input screen.

When CHARACTER INPUT button  A is pressed, the character input screen is displayed.

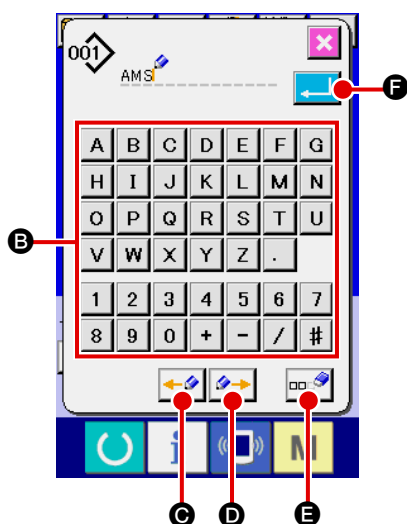

### ③ Input the character.

Press CHARACTER button B you desire to input and the input of character can be performed.

As many as 255 characters ( A to Z and 0 to 9 ) and symbols( + , - , / , # , . ) can be input. The cursor

can be moved with CURSOR LEFT TRAVEL button  C

and CURSOR RIGHT TRAVEL button  D. When you

desire to delete the inputted character, adjust the cursor to the position of the character you desire to delete and press DELETE button  E.

### ④ Finish the input of character.

When ENTER button  F is pressed, the input of character is finished. After the finish, the inputted character is displayed on the upper part of the data input screen (blue).

## 2-15. Performing new register of pattern button

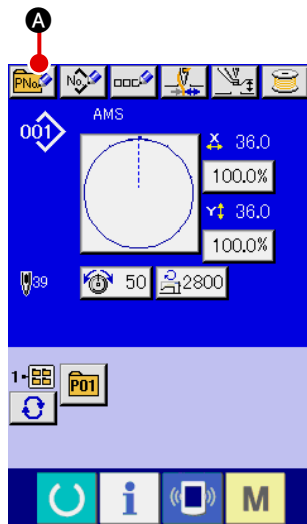

### ① Display the data input screen.

Only in case of the data input screen (blue), new register of the pattern button can be performed. In case of the sewing screen (green), press READY switch  and display the data input screen (blue).

### ② Call the new register of pattern button screen.

Press NEW REGISTER button  (A) and the new register of pattern button screen is displayed.

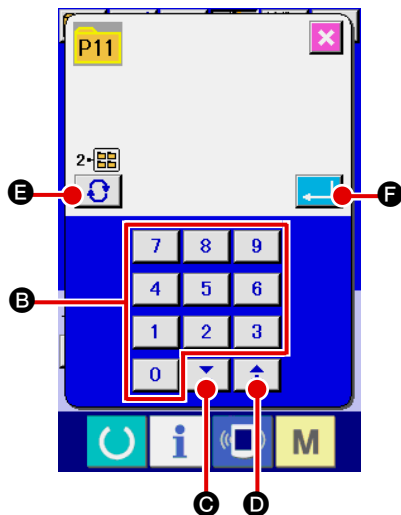

### ③ Input the pattern button No.

Input the pattern button No. you desire to newly register with the ten keys (B). New register to the pattern button No. which has been already registered is prohibited.

It is possible to retrieve the pattern button No. which has not been registered with the “+” or “-” button  (C and D).

### ④ Select the folder to be stored.

It is possible for the pattern buttons to be stored in five folders. As many as 10 pattern buttons can be stored for one folder.

The folder to store the button can be selected with FOLDER SELECTION button  (E).

### ⑤ Determine the pattern No.

Press ENTER button  (F) to determine the pattern button No. to be newly registered and the data input screen at the time of pattern button selection is displayed.





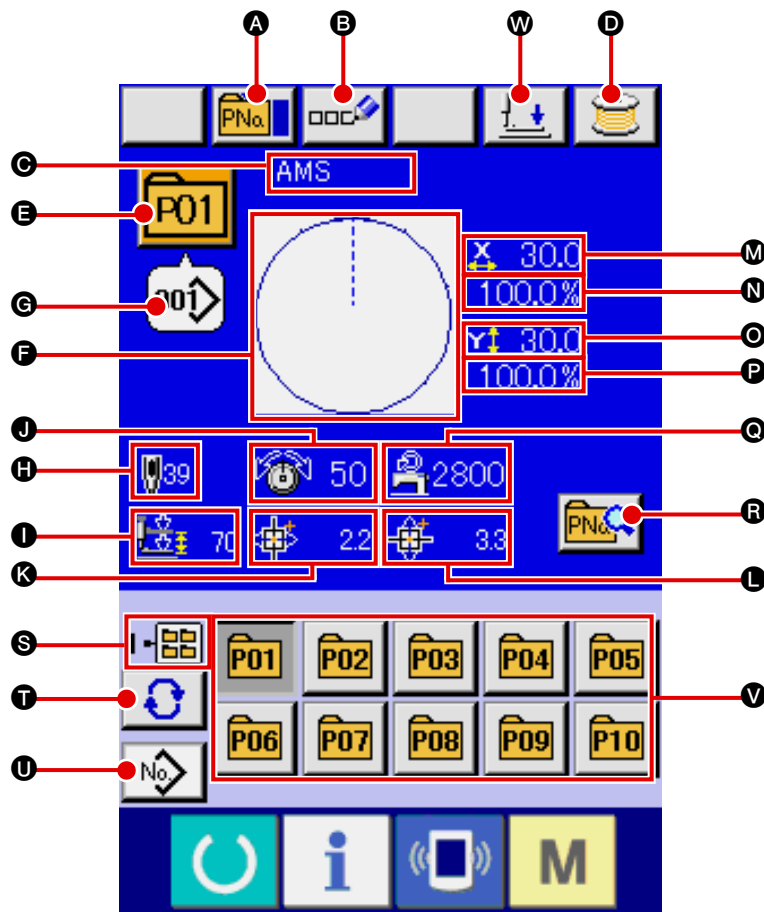

Press P1 to P50 key while the sewing screen is displayed and the presser comes down.  
Be careful that your fingers are not caught in the presser.

## 2-16. LCD display section at the time of pattern button selection

### (1) Pattern button data input screen





	Button and display	Description
A	PATTERN BUTTON COPY button	Pattern button copy screen is displayed. → Refer to “ <a href="#">II-2-19. Copying pattern button</a> ” p.54.
B	PATTERN BUTTON NAME SETTING button	Pattern button name input screen is displayed. → Refer to “ <a href="#">II-2-14. Naming users’ pattern</a> ” p.45.
C	PATTERN BUTTON NAME display	Character which is registered to the pattern button No. being selected is displayed.
D	WINDING BOBBIN button	Bobbin thread can be wound. → Refer to “ <a href="#">II-2-11. Winding bobbin thread</a> ” p.40.
E	PATTERN BUTTON NO. display	Pattern button No. being selected at present is displayed on this button and when the button is pressed, the pattern button No. selection screen is displayed. → Refer to “ <a href="#">II-2-17. Performing pattern button No. selection</a> ” p.51.
F	SEWING SHAPE	Sewing shape which is registered to the pattern button No. being selected is displayed.

	Button and display	Description
Ⓒ	SEWING SHAPE NO.	<p>Sewing shape which is registered to the pattern button No. being selected is displayed. There are 4 kinds below of the kinds of sewing shape.</p> <p> : Users' pattern</p> <p> : Vector format data</p> <p> : M3 data</p> <p> : Sewing standard format</p> <p>* Be sure to use the media that has been formatted with IP-420. For the formatting procedure of the media, refer to <b>"II-2-28. Performing formatting of the media" p.81.</b></p>
Ⓓ	TOTAL NO. OF STITCHES	Total number of stitches of the pattern which is registered to the pattern button No. being selected is displayed.
Ⓔ	2-STEP STROKE display	2-step stroke value registered to the pattern button No. being selected is displayed.
Ⓕ	THREAD TENSION display	Thread tension value which is registered to the pattern button No. being selected is displayed.
Ⓖ	TRAVEL AMOUNT IN X DIRECTION display	Travel amount in X direction which is registered to the pattern button No. being selected is displayed.
Ⓗ	TRAVEL AMOUNT IN Y DIRECTION display	Travel amount in Y direction which is registered to the pattern button No. being selected is displayed.
Ⓜ	X ACTUAL SIZE VALUE display	X actual size value which is registered to the pattern button No. being selected is displayed.
Ⓝ	X SCALE RATE display	X scale rate which is registered to the pattern button No. being selected is displayed.
Ⓒ	Y ACTUAL SIZE VALUE display	Y actual size value which is registered to the pattern button No. being selected is displayed.
Ⓓ	Y SCALE RATE display	Y scale rate which is registered to the pattern button No. being selected is displayed.
Ⓒ	MAX. SPEED LIMITATION	Maximum speed limitation which is registered to the pattern button No. being selected is displayed.
Ⓖ	PATTERN BUTTON EDIT button	Pattern button edit screen is displayed.
Ⓢ	FOLDER NO. display	Folder No. in which the displayed pattern buttons are stored is displayed.
Ⓗ	FOLDER SELECTION button	Folders to display the pattern button are displayed in order.
Ⓔ	SEWING SHAPE SELECTION DATA INPUT SCREEN DISPLAY button	<p>Sewing shape data input screen is displayed.</p> <p>→ Refer to <b>"II-2-4.(1) Sewing shape data input screen" p.26.</b></p>
Ⓔ	PATTERN button	<p>Pattern buttons stored in Ⓢ Folder No. are displayed.</p> <p>→ Refer to <b>"II-2-15. Performing new register of pattern button" p.46.</b></p>
Ⓔ	PRESSER DOWN button	<p>Presser can be lowered and the presser down screen is displayed.</p> <p>To raise the presser, press the presser up button which is displayed in the presser down screen.</p>

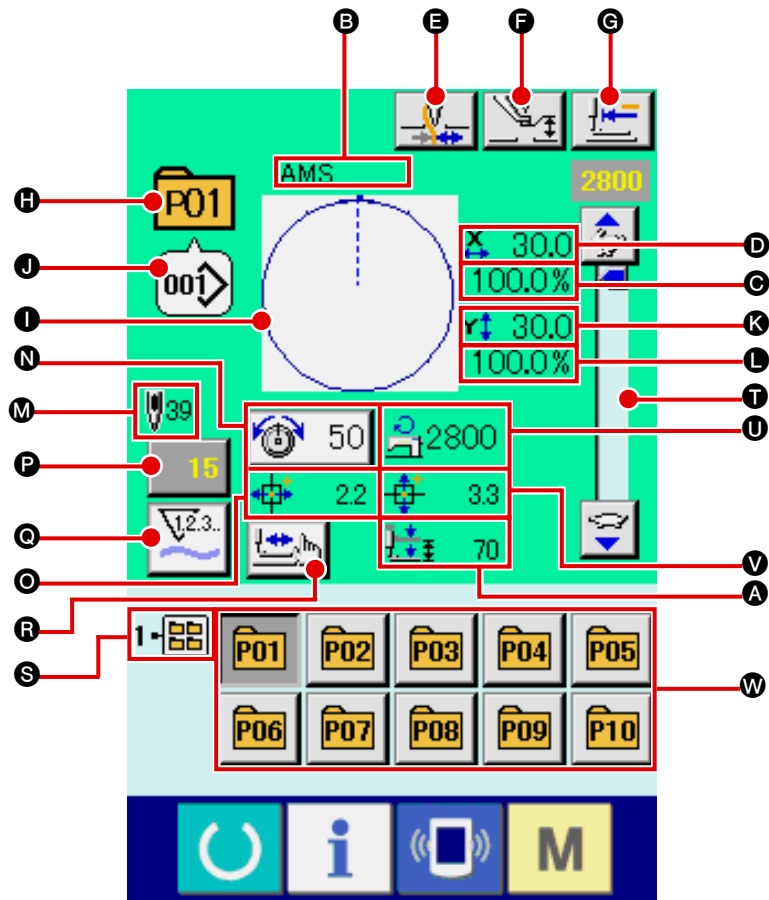
## (2) Sewing screen



	Button and display	Description
A	2-STEP STROKE display	2-step stroke value registered to the pattern button No. during sewing is displayed.
B	PATTERN BUTTON NAME display	Character which is registered to the pattern button No. being sewn is displayed.
C	X SCALE RATE display	Scale rate in X direction which is registered to the pattern button No. being sewn is displayed.
D	X ACTUAL SIZE VALUE display	Actual size value in X direction which is registered to the pattern button No. being sewn is displayed.
E	THREAD CLAMP button	Effective/ineffective of thread clamp is selected.  : Thread clamp ineffective  : Thread clamp effective

	<b>Button and display</b>	<b>Description</b>
<b>F</b>	INTERMEDIATE PRESSER SETTING button	The intermediate presser is lowered and the intermediate presser reference value change screen is displayed. → Refer to. “ <b>II-2-6. Changing item data</b> ” p.32.
<b>G</b>	RETURN TO ORIGIN button	Presser is returned to the start of sewing and is raised at the time of temporary stop.
<b>H</b>	PATTERN NO. display	Pattern button No. being sewn is displayed.
<b>I</b>	SEWING SHAPE display	Sewing shape being sewn is displayed.
<b>J</b>	SEWING SHAPE NO. display	Kind of sewing and sewing shape No. which are registered to the pattern being sewn are displayed.
<b>K</b>	Y ACTUAL SIZE VALUE display	Actual Y size value which is registered to the pattern button No. being selected is displayed.
<b>L</b>	Y SCALE RATE display	Y scale rate which is registered to the pattern button No. being sewn is displayed.
<b>M</b>	TOTAL NO. OF STITCHES OF SEWING SHAPE display	Total number of stitches of sewing shape which is registered to the pattern button No. being sewn is displayed.
<b>N</b>	NEEDLE THREAD TENSION SETTING button	Needle thread tension value which is set to the pattern data being selected at present is displayed on this button and when the button is pressed, the item data change screen is displayed. → Refer to. “ <b>II-2-6. Changing item data</b> ” p.32.
<b>O</b>	TRAVEL AMOUNT IN X DIRECTION display	Travel amount in X direction which is registered to the pattern button No. being sewn is displayed.
<b>P</b>	COUNTER VALUE CHANGE button	Existing counter value is displayed on this button. When the button is pressed, the counter value change screen is displayed. → Refer to “ <b>II-2-12. Using counter</b> ” p.41.
<b>Q</b>	COUNTER CHANGEOVER button	The counter display can be changed over among the sewing counter, No. of pcs. counter and bobbin counter. → Refer to “ <b>II-2-12. Using counter</b> ” p.41.
<b>R</b>	STEP SEWING button	The step sewing screen is displayed. Checking the pattern shape can be performed. → Refer to “ <b>II-2-7. Checking pattern shape</b> ” p.34.
<b>S</b>	FOLDER NO. display	Folder No. in which the displayed pattern register buttons are stored is displayed.
<b>T</b>	SPEED variable resistor	Number of revolutions of the sewing machine can be changed.
<b>U</b>	MAX. SPEED LIMITATION display	Maximum speed limitation which is registered to the pattern button No. being sewn is displayed.
<b>V</b>	TRAVEL AMOUNT IN Y DIRECTION display	Travel amount in Y direction which is registered to the pattern button No. being sewn is displayed.
<b>W</b>	PATTERN REGISTER button	Pattern button which is stored in <b>S</b> FOLDER NO. is displayed. → Refer to “ <b>II-2-15. Performing new register of pattern button</b> ” p.46.

## 2-17. Performing pattern button No. selection

### (1) Selection from the data input screen

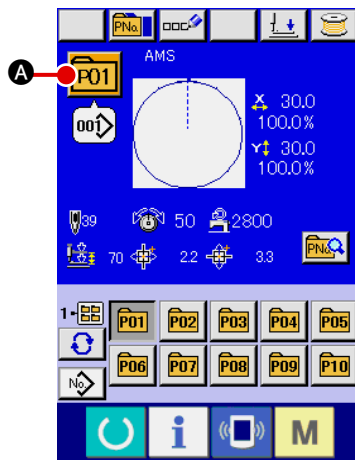

#### ① Display the data input screen.

In case of the data input screen (blue), it is possible to select the pattern button No. In case of the sewing screen (green), press READY switch  to display the data input screen.

#### ② Call the pattern button No. selection screen.

When PATTERN BUTTON NO. SELECTION button  **A** is pressed, the pattern button No. selection screen is displayed. Pattern button No. which is selected at present and the contents are displayed on the upper part of the screen, and the list of the pattern button No. buttons which have been registered is displayed on the lower part of the screen.

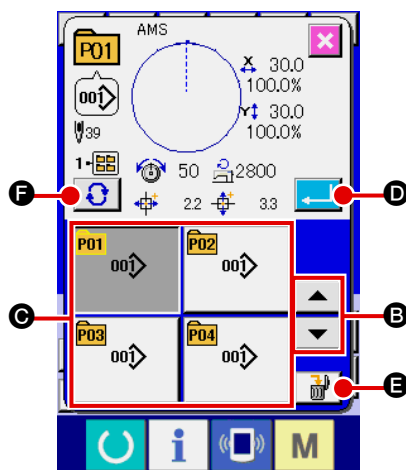

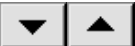

#### ③ Select the pattern button No.

When UP or DOWN SCROLL button  **B** is pressed, pattern button No. button **C** which have been registered are changed over in order. The contents of sewing data which have been inputted in the pattern button No. are displayed in the button. Here, press the pattern button No. button **C** you desire to select.

#### ④ Determine the pattern button No.

When ENTER button  **D** is pressed, the pattern button No. selection screen is closed and the selection is finished. However, the pattern buttons which are registered to the combination sewing cannot be deleted.

\* When you desire to delete the pattern button which has been registered, press DELETE  **E** button. However, the pattern buttons which are registered to the combination sewing cannot be deleted.

\* For the pattern No. to be displayed, press FOLDER SELECTION  **F** button and pattern button Nos. which have been stored in the specified folder are displayed in the list. When the folder No. is not displayed, all pattern Nos. which have been registered are displayed.

## (2) Selection by means of the shortcut button



### WARNING :

Make sure without fail of the contour of the sewing pattern after selection of the sewing pattern. If the sewing pattern extends outside the work clamp feet, the needle will interfere with the work clamp.

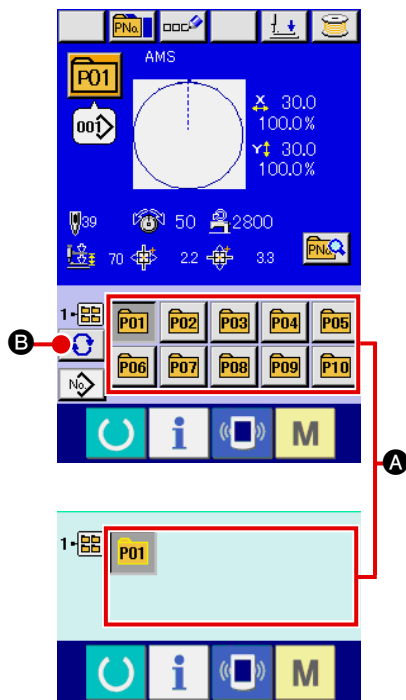

### ① Display the data input screen or the sewing screen.

When the pattern is registered to the folder, pattern buttons **A** are surely displayed on the lower side of the screen of the data input screen or sewing screen.

### ② Select the pattern No.

Pattern button is displayed with every folder which is specified when the pattern is newly created.

When FOLDER SELECTION button  **B** is pressed, the pattern button to be displayed is changed. Display and press the button of the pattern button No. you desire to sew. When it is pressed, the pattern button No. is selected.



## 2-18. Changing contents of pattern button

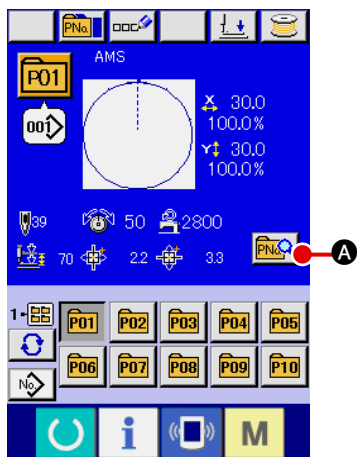

- ① **Display the data input screen at the time of pattern button selection.**

Only in case of the data input screen (blue) at the time of pattern selection, it is possible to change the contents of pattern. In case of the sewing screen (green), press READY switch  to display the data input screen at the time of pattern button selection.

- ② **Display the pattern button data change screen.**

When PATTERN BUTTON DATA CHANGE button  **A** is pressed, the pattern button data change screen is displayed.

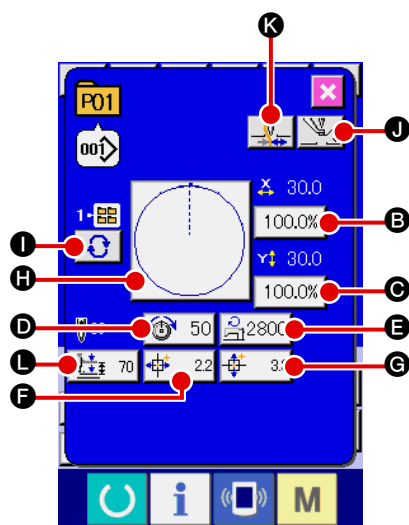

- ③ **Display the input screen of the item data you desire to change.**

Data that can be changed are 11 items below.

	Item	Input range	Initial value
<b>B</b>	Scale rate in X direction	1.0 to 400.0(%)	100.0
<b>C</b>	Scale rate in Y direction	1.0 to 400.0(%)	100.0
<b>D</b>	Thread tension	0 to 200	Pattern set value
<b>E</b>	Max. speed limitation	200 to 2800 (sti/min)	2800
<b>F</b>	Travel amount in X direction	2516 : -127.0 to +127.0 (mm) 3020 : -152.0 to +152.0 (mm)	0.0
<b>G</b>	Travel amount in Y direction	2516 : -82.0 to +82.0 (mm) 3020 : -102.0 to +102.0 (mm)	0.0
<b>H</b>	Sewing shape	-	-
<b>I</b>	Folder No.	1 to 5	-
<b>J</b>	Intermediate presser	0.0 to 3.5 (mm) (Max. 0.0 to 7.0 (mm))	Pattern set value
<b>K</b>	Thread clamp	With/without	With
<b>L</b>	2-step stroke height	Air-driven type : 10 to 300	70

When pressing each button of **B** through **H** and **J**, the item data input screen is displayed. When the buttons of **I** and **K** are pressed, Folder Nos. and With/without thread clamp are changed over.

- \* **B** Scale rate in X direction and **C** Scale rate in Y direction can be changed to the actual size value input by selection of memory switch **U064**.
- \* Max. input range and initial value of max. speed limitation **D** are determined with memory switch **U001**.
- \* The input range of travel amount in X direction **F** and travel amount in Y direction **G** differs according to the sewing range.

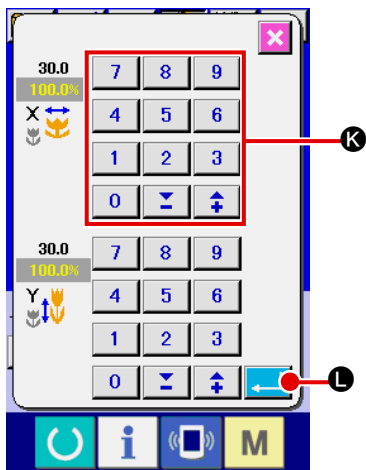

④ **Determine the change of item data**

For example, input X scale rate. Press **100.0%** **B** to display the item data input screen. Input the value you desire with the ten keys or + or – key **K**. When ENTER button **L** is pressed, the data is determined.

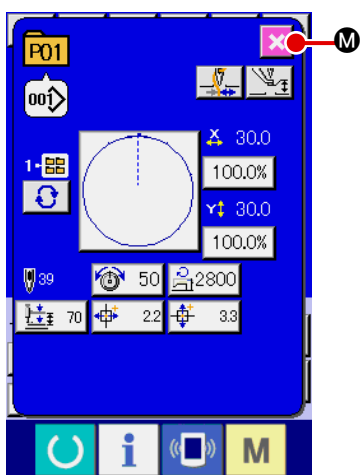

⑤ **Close the pattern button data change screen.**

When the change is over, press CLOSE button **M**. The pattern button data change screen is closed and the screen returns to the data input screen.

\* It can be performed to change the other item data by the same operation.

## 2-19. Copying pattern button

The sewing data of the pattern button No. which has already been registered can be copied to the pattern button No. which is not registered. Overwriting copy of the pattern button is prohibited. When you desire to overwrite, perform it after deleting the pattern button once.

→ Refer to “[II-2-17. Performing pattern button No. selection](#)” p.51.

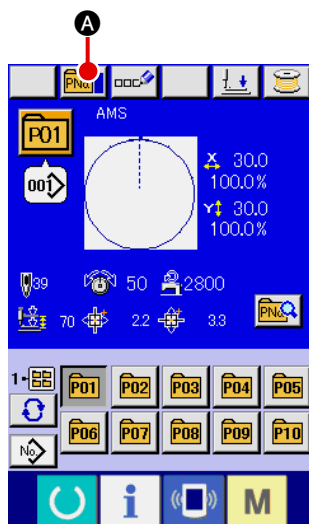

① **Display the data input screen.**

Only in case of the data input screen (blue) at the time of pattern button selection, it is possible to copy. In case of the sewing screen (green), press READY switch **C** to display the data input screen (blue).

② **Call the pattern copy screen.**

When PATTERN BUTTON COPY button **A** is pressed, the pattern button copy (copy source selection) screen is displayed.

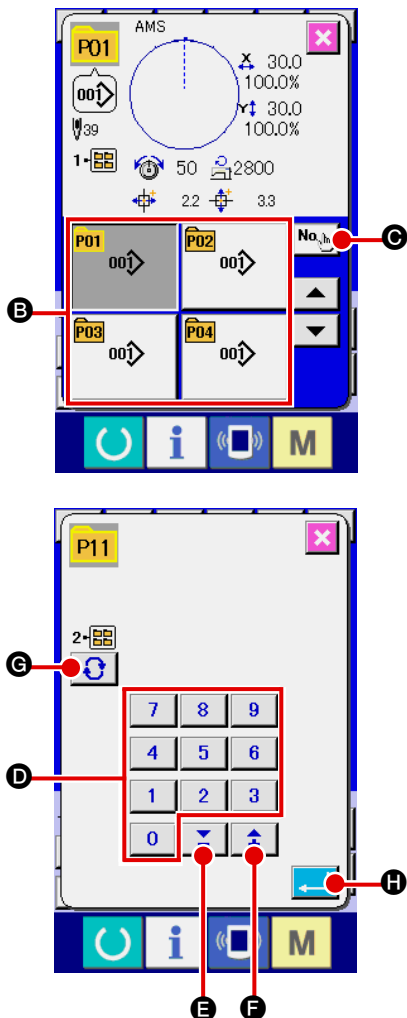



③ **Select the pattern No. of copy source.**

Select the pattern button No. of copy source from the pattern button list button **B**.

Next, press COPY DESTINATION INPUT button  **C** and the copy destination input screen is displayed.

④ **Input the pattern No. of copy destination.**

Input the pattern button No. of copy destination with ten keys **D**. Pattern button No. which is not used yet can be retrieved with – and + buttons   (**F** and **E**).

In addition, the folder to be stored can be selected with FOLDER SELECTION button  **G**.

⑤ **Start copying.**

When ENTER button  **H** is pressed, copying starts. The copied pattern button No. in the selection state returns to the pattern button copy (copy source selection) screen after approximately two seconds.

\* Combination data can be copied in the same way.

## 2-20. Changing sewing mode

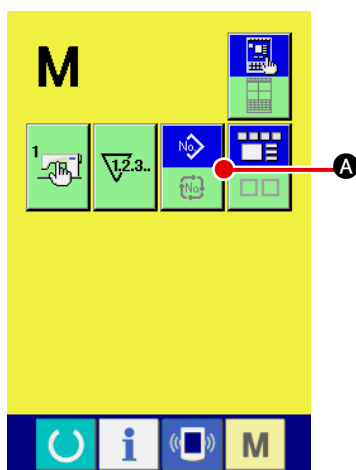

① **Select the sewing mode.**

When **M** switch is pressed in the state that the pattern has been registered, SEWING MODE SELECTION button 

**A** is displayed on the screen. When this button is pressed, the sewing mode changes alternately the individual sewing and the combination sewing. (When the pattern button is not registered, the sewing mode cannot be changed to the combination sewing even when the button is pressed.)

\* The image of the button of sewing mode selection button changes according to the sewing mode which is selected at present.

When individual sewing is selected :



When combination sewing is selected :



## 2-21. LCD display section at the time of combination sewing

The sewing machine is capable of sewing in order by combining the plural pattern data. As many as 30 patterns can be inputted. Use this function when sewing plural different shapes on the sewing product. In addition, it is possible to register as many as 20 of the combination sewing data. Use this function for new creation and copying in case of need.

→ Refer to “[II-2-15. Performing new register of pattern button](#)” p.46  
and “[II-2-19. Copying pattern button](#)” p.54.

### (1) Pattern input screen

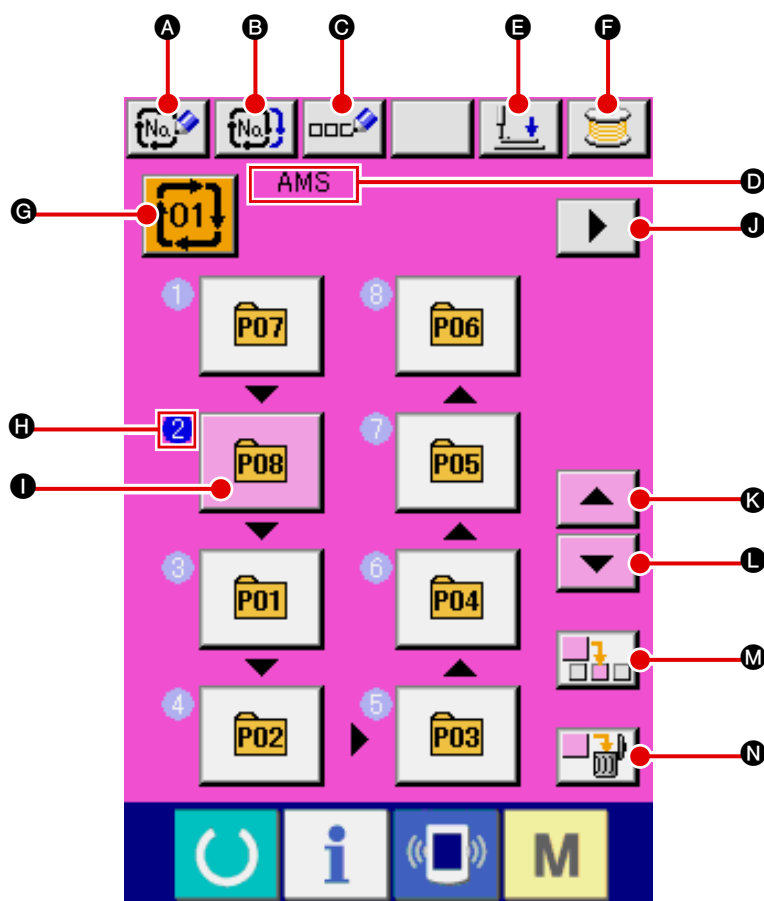



	Button and display	Description
<b>A</b>	COMBINATION DATA NEW REGISTER button	Combination data No. new register screen is displayed. → Refer to “ <a href="#">II-2-15. Performing new register of pattern button</a> ” p.46.
<b>B</b>	COMBINATION DATA COPY button	Combination pattern No. copy screen is displayed. → Refer to “ <a href="#">II-2-19. Copying pattern button</a> ” p.54.
<b>C</b>	COMBINATION DATA NAME INPUT button	Combination data name input screen is displayed. → Refer to “ <a href="#">II-2-14. Naming users' pattern</a> ” p.45.
<b>D</b>	COMBINATION DATA NAME display	Name which is inputted in the combination data being selected is displayed.
<b>E</b>	PRESSER DOWN button	Presser can be lowered and the presser down screen is displayed. To raise the presser, press the presser up button displayed in the presser down screen.
<b>F</b>	BOBBIN WINDING	Bobbin thread can be wound. → Refer to “ <a href="#">II-2-11. Winding bobbin thread</a> ” p.40.

	<b>Button and display</b>	<b>Description</b>
Ⓒ	COMBINATION DATA NO. SELECTION button	Combination data No. being selected is displayed in the button. When the button is pressed, the combination data No. selection screen is displayed.
Ⓗ	SEWING ORDER display	Sewing order of the inputted pattern data is displayed. When the screen is changed over to the sewing screen, the pattern which is sewn first is displayed in blue color. * As many as the number of inputted patterns is displayed in Ⓗ and Ⓛ, display and button.
Ⓛ	PATTERN SELECTION button	Pattern No., shape, number of stitches, etc. which are registered in Ⓗ SEWING ORDER are displayed on the button. When the button is pressed, the pattern selection screen is displayed. * As many as the number of inputted patterns is displayed in Ⓗ and Ⓛ, display and button.
Ⓜ	NEXT PAGE DISPLAY button	This button is displayed when the number of patterns registered to combination data has reached eight or more.
Ⓚ	UP SCROLL button	The pattern No. which is previous to the current one is selected.
Ⓛ	DOWN SCROLL button	The pattern No. which is next to the current one is selected.
Ⓜ	STEP INSERT button	A step is inserted before the pattern No. which is being selected.
Ⓝ	STEP DELETE button	A step which is being selected is delete

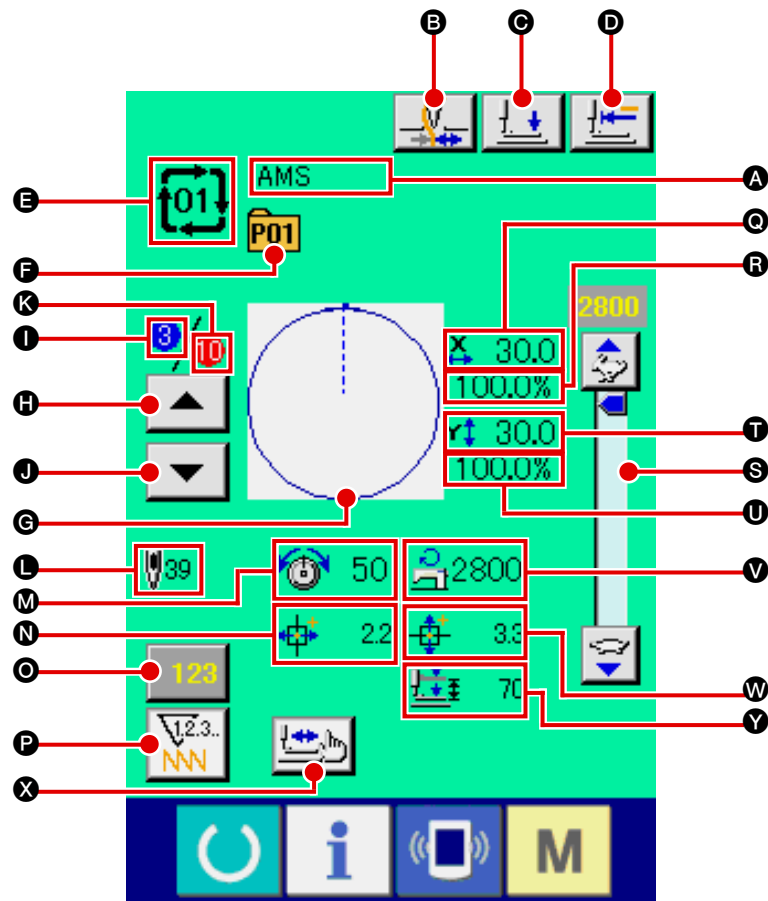
## (2) Sewing screen



	Button and display	Description
<b>A</b>	COMBINATION DATA NAME display	Name which is inputted in the combination data being selected is displayed.
<b>B</b>	THREAD CLAMP button	Effective/ineffective of thread clamp is selected.  : Thread clamp ineffective  : Thread clamp effective
<b>C</b>	PRESSER DOWN button	Presser can be lowered and the presser down screen is displayed. To raise the presser, press the presser up button displayed in the presser down screen.
<b>D</b>	RETURN TO ORIGIN button	This button returns the presser to the start of sewing and raises the presser when the present presser position is on the way of sewing.
<b>E</b>	COMBINATION DATA NO. display	Combination data No. being selected is displayed.
<b>F</b>	PATTERN BUTTON NO. display	Pattern button No. being sewn is displayed.
<b>G</b>	SEWING SHAPE display	Sewing shape which is registered to pattern button No. being sewn is displayed.
<b>H</b>	SEWING ORDER RETURN button	Pattern to be sewn can be returned by one.
<b>I</b>	SEWING ORDER display	Sewing order being sewn at present is displayed.

	<b>Button and display</b>	<b>Description</b>
<b>J</b>	SEWING ORDER ADVANCE button	Pattern to be sewn can be advanced by one.
<b>K</b>	TOTAL NUMBER OF REGISTERS display	Total number of patterns which is registered to combination No. being sewn is displayed.
<b>L</b>	TOTAL NUMBER OF STITCHES display	Total number of stitches of sewing shape being sewn is displayed.
<b>M</b>	THREAD TENSION display	Thread tension value which is registered to pattern button No. being sewn is displayed.
<b>N</b>	TRAVEL AMOUNT IN X DIRECTION display	Travel amount in X direction which is registered to the pattern button No. being sewn is displayed.
<b>O</b>	COUNTER VALUE CHANGE button	Existing counter value is displayed on this button. When the button is pressed, the counter value change screen is displayed. → Refer to “ <b>II-2-12. Using counter</b> ” p.41.
<b>P</b>	COUNTER CHANGEOVER button	The counter display can be changed over among the sewing counter, No. of pcs. counter and bobbin counter. → Refer to “ <b>II-2-12. Using counter</b> ” p.41.
<b>Q</b>	X ACTUAL SIZE AMOUNT display	Actual X size value of the sewing shape which is registered to the pattern button No. being sewn is displayed.
<b>R</b>	X SCALE RATE display	X scale rate of the sewing shape which is registered to the pattern button No. being sewn is displayed.
<b>S</b>	SPEED variable resistor	Number of revolutions of the sewing machine can be changed.
<b>T</b>	Y ACTUAL SIZE AMOUNT display	Actual Y size value of the sewing shape which is registered to the pattern button No. being sewn is displayed.
<b>U</b>	Y SCALE RATE display	Y scale rate of the sewing shape which is registered to the pattern button No. being sewn is displayed.
<b>V</b>	MAX. SPEED LIMITATION display	Maximum speed limitation which is registered to pattern button No. being sewn is displayed.
<b>W</b>	TRAVEL AMOUNT IN Y DIRECTION display	Travel amount in Y direction which is registered to the pattern button No. being sewn is displayed.
<b>X</b>	STEP SEWING button	The step sewing screen is displayed. Checking the pattern shape can be performed. → Refer to “ <b>II-2-7. Checking pattern shape</b> ” p.34.
<b>Y</b>	2-STEP STROKE display	2-step stroke value registered to the pattern button No. during sewing is displayed.

## 2-22. Performing combination sewing

First, change the sewing mode to the combination sewing before performing setting.

→ Refer to “II-2-20. Changing sewing mode” p.55.

### (1) Selection of combination data

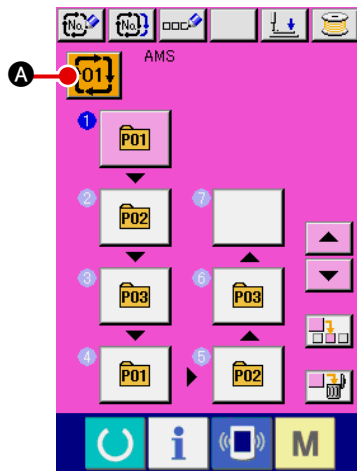

#### ① Display the data input screen.

Only in case of the data input screen (pink), it is possible to select the combination data No.

In case of the sewing screen (green), press READY switch



to display the data input screen (pink).

#### ② Call the combination data No. screen.

When COMBINATION DATA NO. button  **A** is pressed, the combination data No. selection screen is displayed. Combination data No. which is selected at present and the contents are displayed in the upper part of the screen, and other combination data No. buttons which have been registered are displayed in the lower part of the screen.

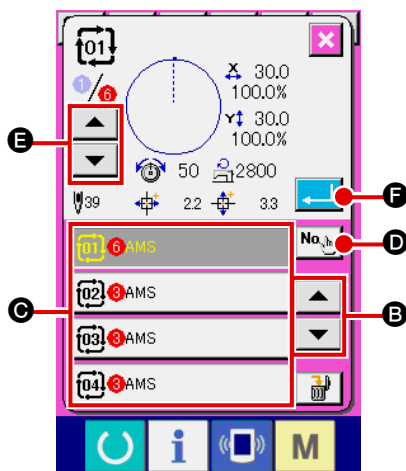

#### ③ Select the combination data No.

When UP/DOWN button  **E** is pressed, combination data No. buttons **C** which have been registered are changed over in order.

It is also possible to display the combination data No. input screen using NUMBER INPUT button  **D** and input a combination data No. directly.

Here, press the combination data No. buttons **C** you desire to select.

When STEP CONFIRMATION button  **E** is pressed, the sewing shapes of patterns which have been registered in the combination data and the like are changed over in order and displayed.

#### ④ Determine the combination data No.

When ENTER button  **F** is pressed, the combination data No. selection screen is closed and the selection is finished.



## (2) Creating procedure of the combination data

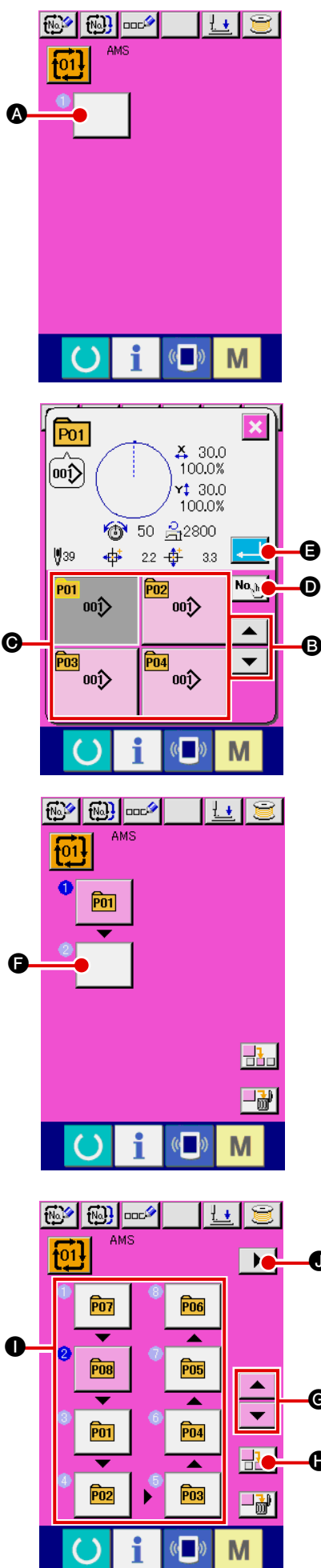

### ① Display the data input screen.

Only in case of the data input screen (pink) it is possible to input the combination data. In case of the sewing screen (green), press

READY switch  to display the data input screen (pink). Pattern No. has not been registered in the initial state, and the first pattern selection button is displayed in the blank state.

### ② Display the pattern No. selection screen.

When PATTERN SELECTION button  (A) is pressed, the pattern No. selection screen is displayed.

### ③ Select the pattern No.

When UP/DOWN SCROLL button  (B) is pressed, pattern No. buttons (C) which have been registered are changed over in order.

It is also possible to display the pattern No. input screen by means of NUMBER INPUT button  (D) and input a pattern No. directly. The contents of pattern data are displayed in the buttons. Here, press the pattern No. buttons you desire to select.



### ④ Determine the pattern No.

When ENTER button  (E) is pressed, the pattern No. selection screen is closed and the selection is finished.

### ⑤ Repeat steps ② through ④ as many as the number of pattern Nos. you desire to register.

When the first register is determined, the second pattern selection button  (F) is displayed.

Repeat steps ② through ④ as many as the number of pattern Nos. you desire to register.

When UP or DOWN SCROLL button  (G) is pressed, the PATTERN NO. button can be selected. The selected PATTERN NO. button is displayed in pink .

When the PATTERN NO. INSERT button  (H) is pressed, a step is inserted before the pattern No. being selected (displayed in pink). When PATTERN NO. button (I) being displayed is pressed to select a different pattern No., the pattern No. is changed over.

If the programmed combination data extends over two or more screens, the next screen can be displayed by means of SCREEN SCROLL button  (J).

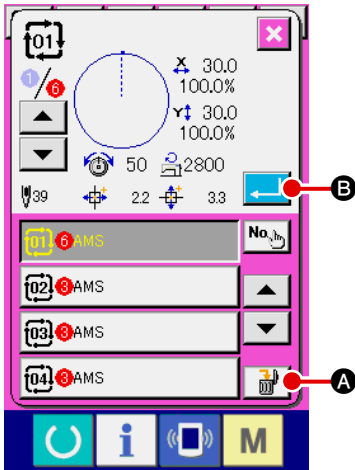

### (3) Deleting procedure of the combination data



① **Select the combination data No.**

Perform steps ① to ③ of “[II-2-22. \(1\) Selection of combination data](#)” p.60 to display the combination data to be deleted.

② **Performing deleting the combination data.**

When DATA DELETION button  **A** is pressed, the combination data deletion confirmation pop-up is displayed. Here, press ENTER button  **B**, and the selected combination data is deleted.

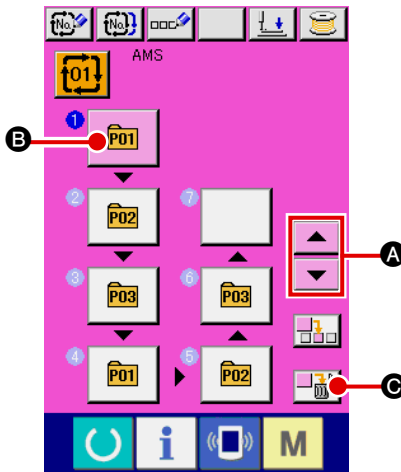

### (4) Deleting procedure of the step of the combination data



① **Select the combination data No.**



Perform steps ① to ② of “[II-2-22. \(1\) Selection of combination data](#)” p.60 to make the state that the combination data including the step you desire to delete has been selected.

② **Display the pattern No. selection screen.**

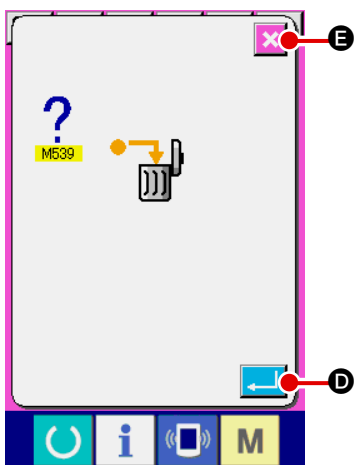
Press UP/DOWN SCROLL button  **A** to bring the PATTERN SELECT button for the step to be deleted under the selected state  **B**. Then, when STEP DELETE button  **C** is pressed, the data step delete popup window is displayed.



③ **Performing deleting the step of the selected combination data.**

When ENTER button  **D** is pressed, the selected combination data step is deleted. When the CANCEL button  **E** is pressed, no data is deleted and the screen is restored to the data input screen.

## 2-23. Using the simple operation mode

With IP-420, the SIMPLE OPERATION mode is available.

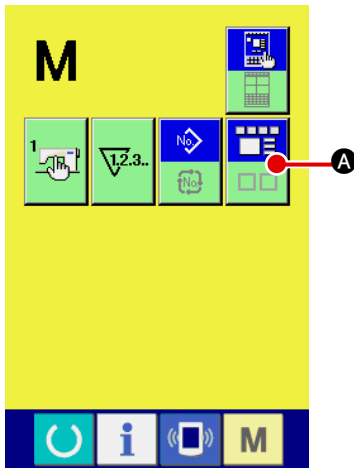

### ① Select the sewing mode.

When the **M** key is pressed, SCREEN MODE SELECT

button  is displayed on the screen. When this button is pressed, the screen mode is changed over between the normal operation and the simple operation.

When the normal operation is selected:









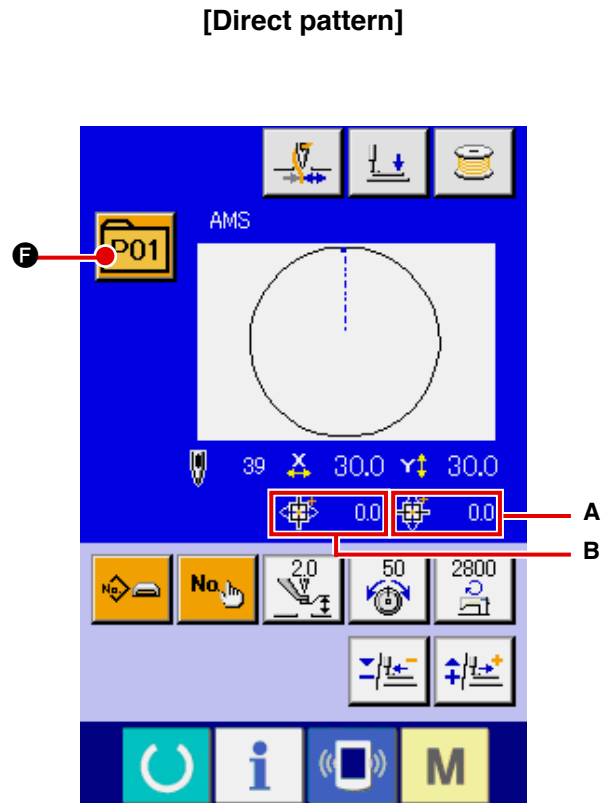
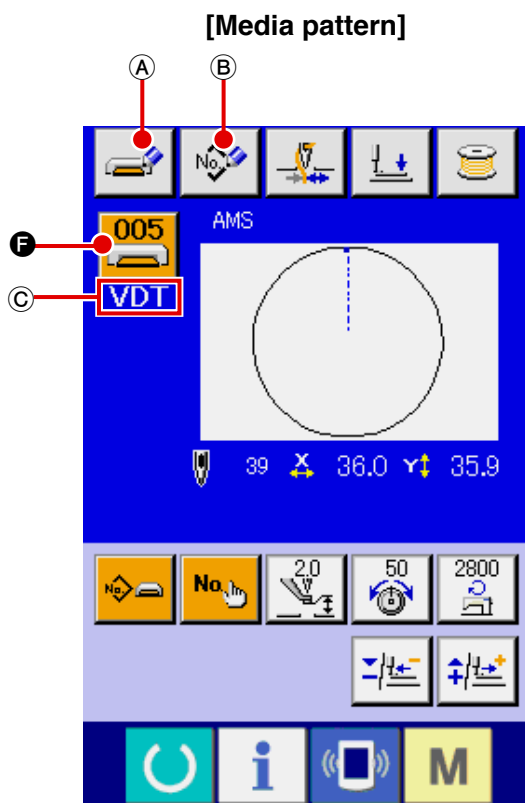
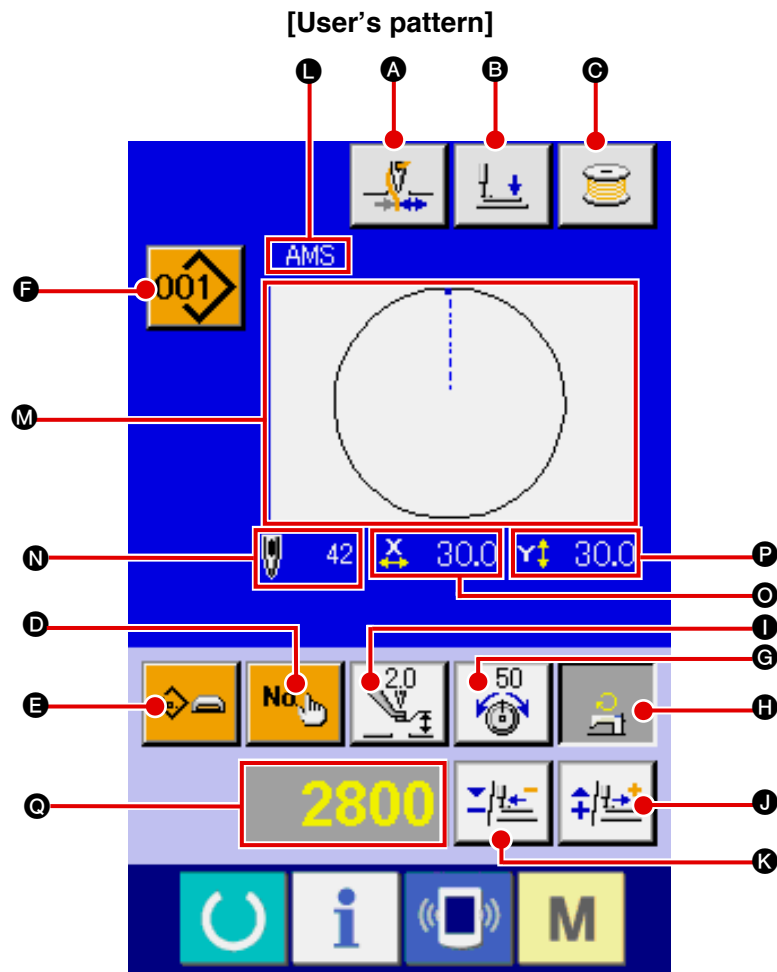

When the simple operation is selected:



## 2-24. LCD display when the simple operation is selected

### (1) Data input screen (individual sewing)



	Button and display	Description
A	THREAD CLAMP button	Effective/ineffective of thread clamp is selected.  : Thread clamp ineffective  : Thread clamp effective
B	PRESSER DOWN button	Feeding frame and intermediate presser are lowered and the presser down screen is displayed.
C	BOBBIN WINDER button	Bobbin thread can be wound. → Refer to “ <a href="#">II-2-11. Winding bobbin thread</a> ” p.40.
D	PATTERN NO. SETTING button	Pattern No. is set. Registered pattern No. is retrieved using PLUS button <b>J</b> and MINUS button <b>K</b> .
E	PATTERN TYPE SETTING button	Pattern type is specified. The pattern type is changed over among the following three different ones using PLUS button <b>J</b> and MINUS button <b>K</b> to select a desired one.  : User's pattern  : Vector form data  : M3 data  : Standard format of sewing  : Direct pattern The selected pattern type is indicated on edit data display <b>C</b> . *A type to which no pattern is registered cannot be selected.
F	PATTERN LIST button	Pattern No. and type which are currently selected are indicated on the button. When the button is pressed, the selected pattern list screen is displayed for the pattern selection.
G	NEEDLE THREAD TENSION SETTING button	The current needle thread tension reference value is indicated on the button. When the button is pressed, the thread tension reference value can be changed. During the setting procedure, the thread tension reference value is indicated on edit data display <b>C</b> . The thread tension value is increased/decreased in increments of 1 using PLUS button <b>J</b> or MINUS button <b>K</b> . → Refer to “ <a href="#">II-2-6. Changing item data</a> ” p.32.
H	MAX SPEED LIMITATION SETTING button	The current max. speed limitation is indicated on the button. When the button is pressed, the max. speed limitation can be changed. During the setting procedure, the max. speed limitation is indicated on edit data display <b>C</b> . The max. speed limitation is increased/decreased in increments of 100 sti/min using PLUS button <b>J</b> or MINUS button <b>K</b> . → Refer to “ <a href="#">II-2-6. Changing item data</a> ” p.32.
I	INTERMEDIATE PRESSER HEIGHT REFERENCE VALUE SETTING button	The current intermediate presser height reference value is indicated on the button. When the button is pressed, the intermediate presser height reference value can be changed. During the setting procedure, the intermediate presser height reference value is indicated on edit data display <b>C</b> . The intermediate presser height reference value is increased/decreased in increments of 0.1 mm using PLUS button <b>J</b> or MINUS button <b>K</b> . → Refer to “ <a href="#">II-2-6. Changing item data</a> ” p.32.
J	PLUS button	The value for the selected item is increased in increments of the reference unit.
K	MINUS button	The value for the selected item is decreased in increments of the reference unit.
L	PATTERN NAME display	The name of the currently selected pattern is displayed.

	Button and display	Description
Ⓜ	SEWING SHAPE display	The sewing shape of the currently selected pattern is displayed
Ⓝ	NUMBER OF STITCHES display	The number of stitches for the currently selected pattern is displayed.
Ⓞ	X ACTUAL SIZE VALUE display	The actual X size value of the sewing shape which is being selected is displayed. When an actual value input is selected, the X ACTUAL VALUE SETTING button is displayed according to the setting of MEMORY switch <b>U064</b> . → Refer to “ <b>II-2-6. Changing item data</b> ” p.32.
Ⓟ	Y ACTUAL SIZE VALUE display	The actual Y size value of the sewing shape which is being selected is displayed. When an actual value input is selected, the Y ACTUAL VALUE SETTING button is displayed according to the setting of MEMORY switch <b>U064</b> . → Refer to “ <b>II-2-6. Changing item data</b> ” p.32.
Ⓠ	EDIT DATA display	The data which is being edited on the currently selected edit item is displayed. * When no edit item is selected, this display is not given.
Ⓐ	MEDIA PATTERN WRITE button	Data on a media pattern is written. When this button is pressed, the new media pattern registration screen is displayed. * This button is displayed when the media pattern is selected.
Ⓑ	USER'S PATTERN WRITE button	Data on a user's pattern is written. When this button is pressed, the new user's pattern registration screen is displayed. * This button is displayed when the media pattern is selected.
Ⓒ	SEWING DATA TYPE display	The type of data read from a medium is displayed. <b>VDT</b> : Vector form data <b>M3</b> : M3 data <b>DAT</b> : Standard format of sewing * This display is given when the media pattern is selected.
Ⓐ	TRAVEL AMOUNT IN X DIRECTION display	The amount of travel in the X direction which is registered to the pattern button No. being selected is displayed. * This display is given when a direct pattern is selected.
Ⓑ	TRAVEL AMOUNT IN Y DIRECTION display	The amount of travel in the Y direction which is registered to the pattern button No. being selected is displayed. * This display is given when a direct pattern is selected.

(2) Sewing screen (individual sewing)

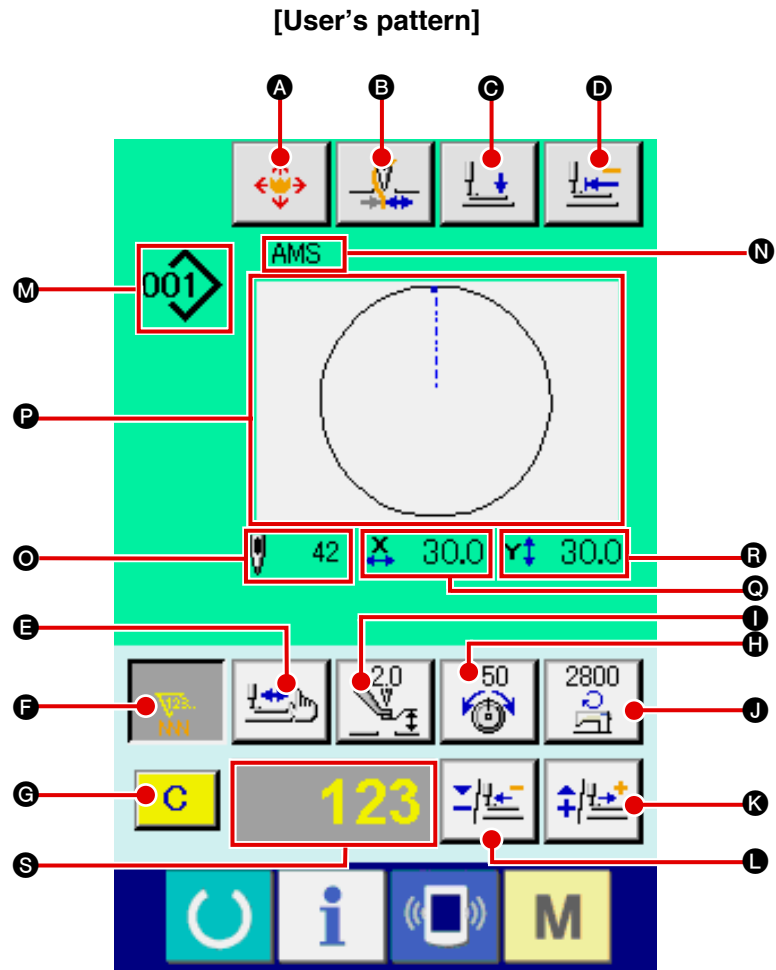

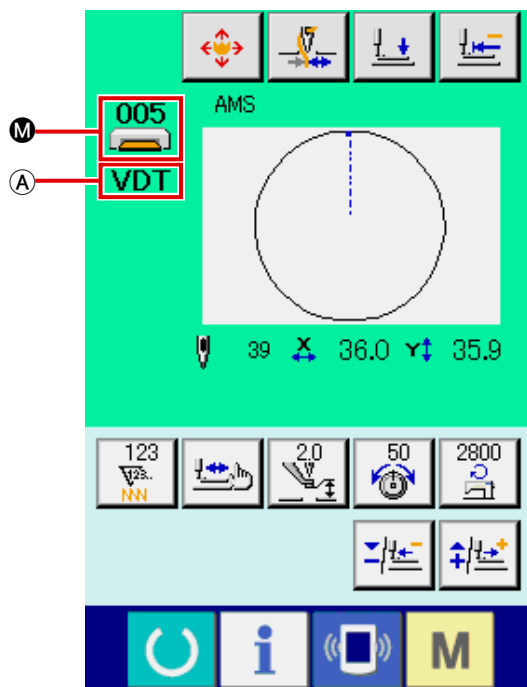

[Media pattern]

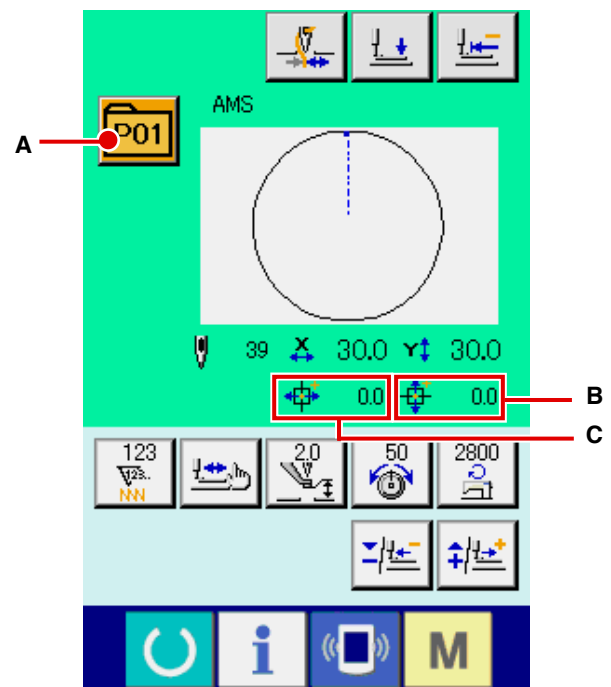

[Direct pattern]



	Button and display	Description
Ⓐ	PATTERN BUTTON MOVE button	The pattern button move screen is displayed. →Refer to "II-2-10. When setting of sewing product is difficult because of interruption of needle tip" p.39.
Ⓑ	THREAD CLAMP button	Effective/ineffective of thread clamp is selected.  : Thread clamp ineffective  : Thread clamp effective
Ⓒ	PRESSER DOWN button	Feeding frame and intermediate presser are lowered and the presser down screen is displayed.
Ⓓ	RETURN TO ORIGIN button	The work clamp is returned to the start of sewing and raised to its upper position at the time of a temporary stop.
Ⓔ	SHAPE CHECK button	The shape of the pattern which is being selected is checked using PLUS button Ⓚ or MINUS button Ⓛ. The current number of stitches is indicated on edit data display Ⓢ. →Refer to "II-2-7. Checking the pattern shape" p.34.
Ⓕ	COUNTER VALUE CHANGE button	The counter value is changed using PLUS button Ⓚ or MINUS button Ⓛ. The counter value is indicated on the button. When the button is pressed, Ⓒ is displayed to allow the counter value to be changed. The current counter value is indicated on edit data display Ⓢ. →Refer to "II-2-12. Using counter" p.41.
Ⓖ	CLEAR button	The counter value is cleared. * This button is displayed only when COUNTER VALUE CHANGE button Ⓕ is being selected.
Ⓗ	NEEDLE THREAD TENSION SETTING button	The current needle thread tension reference value is indicated on the button. When the button is pressed, the reference value of the thread tension can be set. During the setting procedure, the thread tension reference value is indicated on edit data display Ⓢ. The thread tension value is increased/decreased in increments of 1 using PLUS button Ⓚ or MINUS button Ⓛ. The thread tension can be changed even during sewing.
Ⓘ	INTERMEDIATE PRESSER HEIGHT REFERENCE VALUE SETTING button	The current intermediate presser height reference value is indicated on the button. When the button is pressed, the intermediate presser height reference value can be set. During the setting procedure, the intermediate presser height reference value is indicated on edit data display Ⓢ. The intermediate presser height reference value is increased/decreased in increments of 0.1 mm using PLUS button Ⓚ or MINUS button Ⓛ.
Ⓙ	SPEED CHANGE button	The speed of stitch of the sewing machine is indicated on the button. When the button is pressed, the speed of stitch can be changed. During the setting procedure, the current speed of the sewing machine is indicated on edit data display Ⓢ. The max. speed limitation is increased/decreased in increments of 100 sti/min using PLUS button Ⓚ or MINUS button Ⓛ.
Ⓚ	PLUS button	The value for the selected item is increased in increments of the reference unit or the needle is moved forward by one stitch.
Ⓛ	MINUS button	The value for the selected item is decreased in increments of the reference unit or the needle is moved backward by one stitch.



	<b>Button and display</b>	<b>Description</b>
<b>M</b>	PATTERN NO./TYPE display	The pattern No. and type of the pattern which is being selected are displayed.
<b>N</b>	PATTERN NAME display	The name of the currently selected pattern is displayed.
<b>O</b>	NUMBER OF STITCHES display	The number of stitches for the currently selected pattern is displayed.
<b>P</b>	SEWING SHAPE display	The sewing shape of the currently selected pattern is displayed.
<b>Q</b>	X ACTUAL SIZE VALUE display	The actual X size value of the sewing shape which is being selected is displayed.
<b>R</b>	Y ACTUAL SIZE VALUE display	The actual Y size value of the sewing shape which is being selected is displayed.
<b>S</b>	EDIT DATA display	The data which is being edited on the currently selected edit item is displayed. * When no edit item is selected, this display is not given.
<b>A</b>	SEWING DATA TYPE display	The type of data read from a medium is displayed. <b>VDT</b> : Vector form data <b>M3</b> : M3 data <b>DAT</b> : Standard format of sewing * This display is given when the media pattern is selected.
<b>A</b>	PATTERN LIST button	Pattern No. and type which are currently selected are indicated on the button. When the button is pressed, the selected pattern list screen is displayed for the pattern selection.
<b>B</b>	TRAVEL AMOUNT IN X DIRECTION display	The amount of travel in the X direction which is registered to the pattern button No. being selected is displayed. * This display is given when a direct pattern is selected.
<b>C</b>	TRAVEL AMOUNT IN Y DIRECTION display	The amount of travel in the Y direction which is registered to the pattern button No. being selected is displayed. * This display is given when a direct pattern is selected.

### (3) Data input screen (combination sewing)

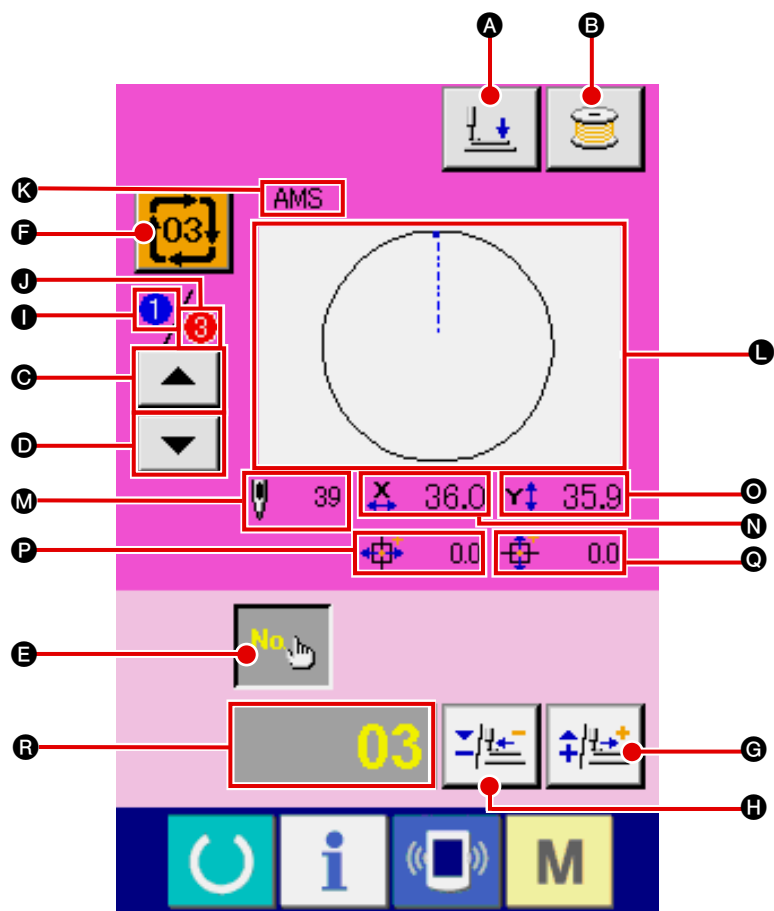



	Button and display	Description
Ⓐ	PRESSER DOWN button	Feeding frame and intermediate presser are lowered and the presser down screen is displayed.
Ⓑ	BOBBIN WINDER button	Bobbin thread can be wound. → Refer to “ <a href="#">II-2-11. Winding bobbin thread</a> ” p.40.
Ⓒ	SEWING ORDER RETURN button	The pattern No. to be sewn first can be returned to the previous sewing order. The pattern information shown at the upper part of the screen is updated.
Ⓓ	SEWING ORDER ADVANCE button	The pattern No. to be sewn first can be advanced to the next sewing order. The pattern information shown at the upper part of the screen is updated.
Ⓔ	PATTERN No. SETTING button	Pattern No. is set. Registered pattern No. is retrieved using PLUS button Ⓒ and MINUS button Ⓓ.
Ⓕ	PATTERN LIST button	Pattern No. and type which are currently selected are indicated on the button. When the button is pressed, the selected pattern list screen is displayed for the pattern selection.
Ⓖ	PLUS button	The value for the selected item is increased in increments of the reference unit.
Ⓗ	MINUS button	The value for the selected item is decreased in increments of the reference unit.
Ⓘ	SEWING ORDER display	The sewing order of the currently selected pattern data is displayed.
Ⓙ	TOTAL NUMBER OF REGISTERS display	The total number of patterns registered to the cycle pattern which is currently being selected is displayed.

	<b>Button and display</b>	<b>Description</b>
Ⓚ	PATTERN NAME display	The name of the currently selected pattern is displayed.
Ⓛ	SEWING SHAPE display	The sewing shape of the currently selected pattern is displayed.
Ⓜ	NUMBER OF STITCHES display	The number of stitches for the currently selected pattern is displayed.
Ⓝ	X ACTUAL SIZE VALUE display	The actual X size value of the currently selected pattern is displayed.
Ⓞ	Y ACTUAL SIZE VALUE display	The actual Y size value of the currently selected pattern is displayed.
Ⓟ	TRAVEL AMOUNT IN X DIRECTION display	The amount of travel in the X direction of the currently selected pattern is displayed.
Ⓠ	TRAVEL AMOUNT IN Y DIRECTION display	The amount of travel in the Y direction of the currently selected pattern is displayed.
Ⓡ	EDIT DATA display	The data which is being edited on the currently selected edit item is displayed. * When no edit item is selected, this display is not given.

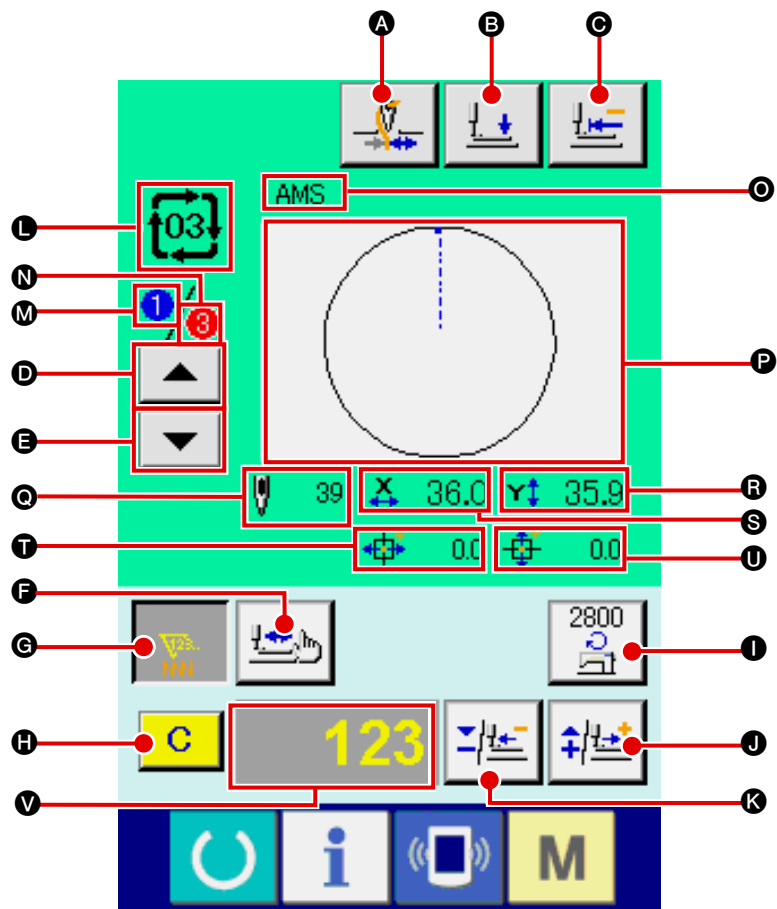
#### (4) Sewing screen (combination sewing)



	Button and display	Description
A	THREAD CLAMP button	Effective/ineffective of thread clamp is selected.  : Thread clamp ineffective  : Thread clamp effective
B	PRESSER DOWN button	Feeding frame and intermediate presser are lowered and the presser down screen is displayed.
C	RETURN TO ORIGIN button	The work clamp is returned to the start of sewing and raised to its upper position at the time of a temporary stop.
D	SEWING ORDER RETURN button	The pattern to be sewn can be returned to the previous one.
E	SEWING ORDER ADVANCE button	The pattern to be sewn can be advanced to the next one.
F	SHAPE CHECK button	The shape of the pattern which is being selected is checked using PLUS button <b>J</b> or MINUS button <b>K</b> . The current number of stitches is indicated on edit data display <b>V</b> . →Refer to " <a href="#">II-2-7. Checking the pattern shape</a> " p.34.

	Button and display	Description
Ⓒ	COUNTER VALUE CHANGE button	The counter value is changed using PLUS button Ⓙ or MINUS button Ⓚ. The counter value is indicated on the button. When the button is pressed, Ⓜ is displayed to allow the counter value to be changed. The current counter value is indicated on edit data display Ⓟ. →Refer to " <a href="#">II-2-12. Using counter</a> " p.41.
Ⓜ	CLEAR button	The counter value is cleared. * This button is displayed only when COUNTER VALUE CHANGE button Ⓒ is being selected.
Ⓡ	SPEED CHANGE button	The speed of stitch of the sewing machine is changed. The speed of stitch can be changed even during sewing. When this button is pressed, the current speed of stitch of the sewing machine is indicated on edit data display Ⓟ. The speed of stitch is increased/decreased in increments of 100 sti/min using PLUS button Ⓙ and MINUS button Ⓚ.
Ⓙ	PLUS button	The value for the selected item is increased in increments of the reference unit or the needle is moved forward by one stitch.
Ⓚ	MINUS button	The value for the selected item is decreased in increments of the reference unit or the needle is moved backward by one stitch.
Ⓛ	PATTERN NO./TYPE display	The pattern No. and type of the pattern which is being selected are displayed.
Ⓜ	SEWING ORDER display	The sewing order of currently selected pattern data is displayed.
Ⓝ	TOTAL NUMBER OF REGISTERS display	The total number of patterns registered to the cycle pattern which is currently being selected is displayed.
Ⓞ	COMBINATION DATA NAME display	The name input in the combination data which is being selected is displayed.
Ⓟ	SEWING SHAPE display	The sewing shape of the currently selected pattern is displayed.
Ⓠ	NUMBER OF STITCHES display	The number of stitches for the currently selected pattern is displayed.
Ⓡ	X ACTUAL SIZE VALUE display	The actual X size value of the currently selected pattern is displayed.
Ⓢ	Y ACTUAL SIZE VALUE display	The actual Y size value of the currently selected pattern is displayed.
Ⓣ	TRAVEL AMOUNT IN X DIRECTION display	The amount of travel in the X direction of the currently selected pattern is displayed.
Ⓤ	TRAVEL AMOUNT IN Y DIRECTION display	The amount of travel in the Y direction of the currently selected pattern is displayed.
Ⓟ	EDIT DATA display	The data which is being edited on the currently selected edit item is displayed. * When no edit item is selected, this display is not given.

## 2-25. Changing memory switch data

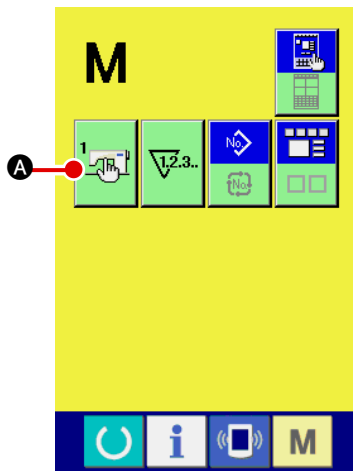

### ① Display the memory switch data list screen.

When MODE key **M** is pressed, memory switch button



**A** is displayed on the screen. When this button is pressed, the memory switch data list screen is displayed.

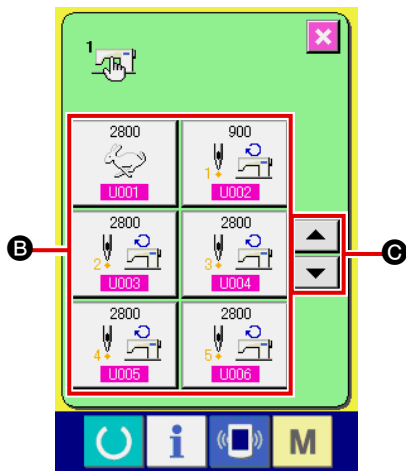

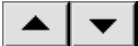

### ② Select the memory switch button you desire to change.

Press UP/DOWN SCROLL button  **C** and select the data item button **B** you desire to change.

### ③ Change the memory switch data.

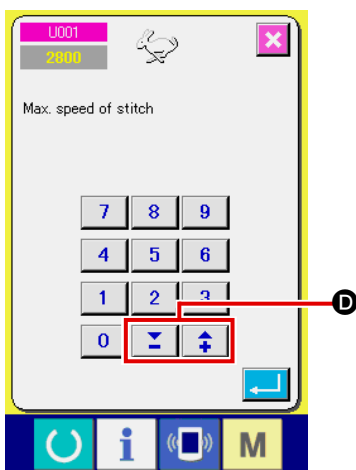
There are data items to change numerals and those to select pictographs in the memory switch data.



No. in pink color such as **U001** is put on the data items to change numerals and the set value can be changed with 

 **D** buttons displayed in the change screen.

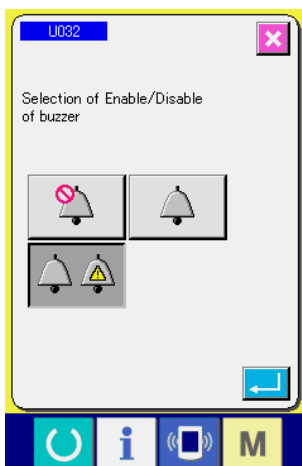

No. in blue color such as **U032** is put on the data items to select pictographs and the pictographs displayed in the change screen can be selected.

→ For the details of memory switch data, refer to "**II-3. MEMORY SWITCH DATA LIST**" p.84.

## 2-26. Using information

Oil replacement (grease-up) time, needle replacement time, cleaning time, etc. can be specified and the warning notice can be performed after the lapse of the specified time.

### (1) Observing the maintenance and inspection information

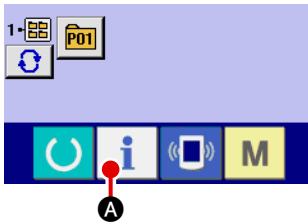

#### ① Display the information screen.

When information key  **A** of the switch seat section is pressed in the data input screen, the information screen is displayed.

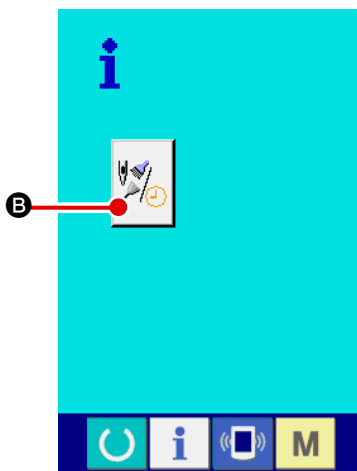

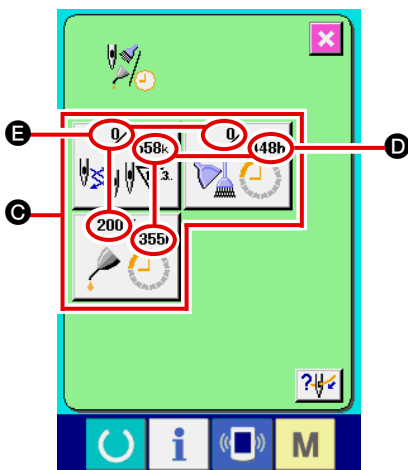

#### ② Display the maintenance and inspection information screen.

Press maintenance and inspection information screen display button  **B** in the information screen.



Information on the following three items is displayed in the maintenance and inspection information screen.

- Needle replacement (1,000 stitches) : 
- Cleaning time (hour) : 
- Oil replacement time (hour) : 

The interval to inform of the inspection for each item in button **C** is displayed at **D**, and remaining time up to the replacement is displayed at **E**. In addition, remaining time up to the replacement can be cleared.

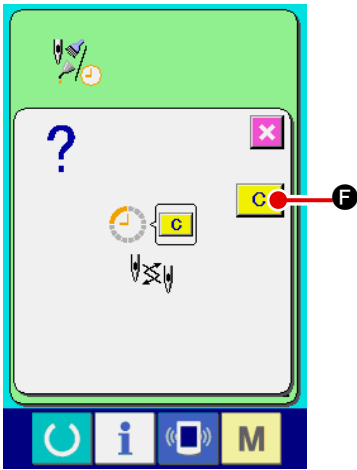

- ③ **Perform clearing remaining time up to the replacement.**  
 When button **C** of the item you desire to clear is pressed, the time of replacement clear screen is displayed. When CLEAR button **C** **F** is pressed, the remaining time up to the replacement is cleared.

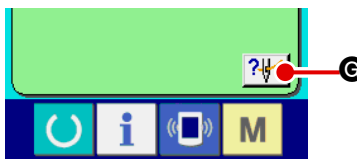

- ④ **Display the threading diagram.**  
 When threading button  **G** displayed in the maintenance and inspection screen is pressed, the needle thread threading diagram is displayed.  
 Observe it when performing threading.

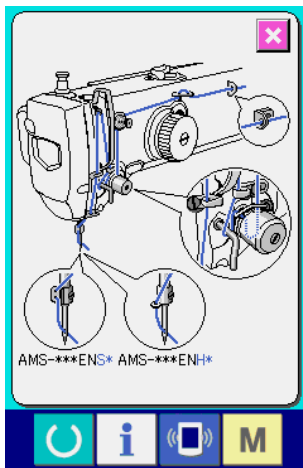

**(2) Releasing procedure of the warning**

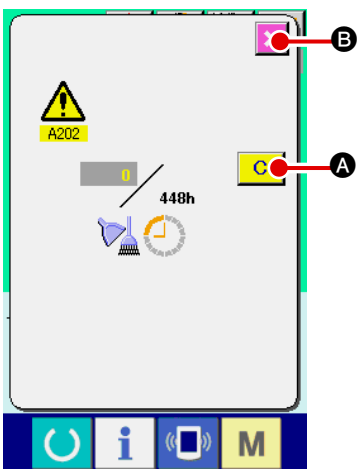

- When the designated inspection time is reached, the warning screen is displayed.  
 In case of clearing the inspection time, press CLEAR button **C**  
**A**. The inspection time is cleared and the pop-up is closed. In case of not clearing the inspection time, press CANCEL button **X** **B** and close the pop-up. Every time one sewing is completed, the warning screen is displayed until the inspection time is cleared.  
 Warning Nos. of the respective items are as follows.
- Needle replacement : A201
  - Cleaning time : A202
  - Oil replacement time : A203

 **For the grease-up portion, refer to the item of "III-1-8. Replenishing the designated places with grease" p.107.**



## 2-27. Using communication function





Communication function can download the sewing data created with other sewing machine, creation of sewing data and sewing data created by editing device PM-1 to the sewing machine. In addition, the function can upload the aforementioned data to the media or personal computer.

As the means of communication, a media slot and USB port are prepared.

- \* However, SU-1 (data server utility) is necessary to perform download/upload from the personal computer.

### (1) Handling possible data

Sewing data that can be handled are 4 kinds below, and the respective data formats are as shown below.

Data name		Extension	Description of data
Vector format data		VD00XXX.VDT	It is the data of needle entry point created with PM-1, and the data format that can be operated in common between JUKI sewing machines.
M3 data		AMS00XXX.M3	Pattern data for the AMS-B, -C and -D Series
Sewing standard format data		SD00XXX.DAT	Data of sewing standard format
Simplified program data		AMS00XXX.PRO	Simplified program data

xxx : file No.

- \* For the simplified program, see the Engineer's Manual.

### (2) Performing communication by using the media

For handling way of the media, read "[II-1. PREFACE](#)" p.18.

### (3) Performing communication by using USB

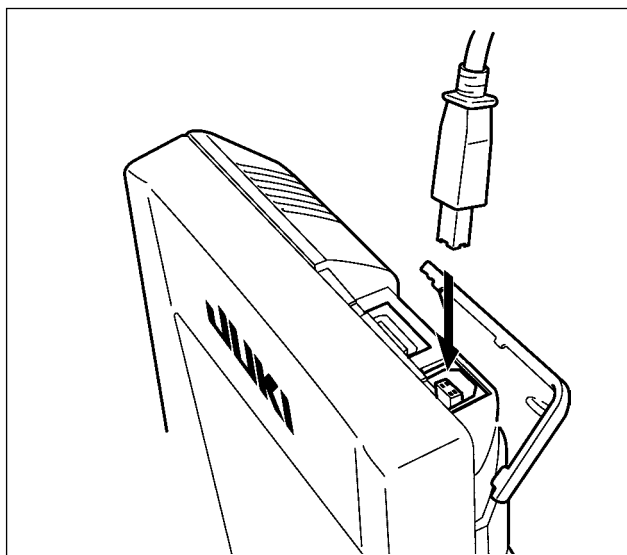

Data can be sent/received to/from a personal computer or the like, by means of a USB cable.



If the contact part becomes dirty, failure of contact will be caused. Do not touch by hand, and control so that dust, oil or other foreign material does not adhere to it. In addition, the inside element is damaged by static electricity or the like. So, be very careful when handling.

#### (4) Take-in of the data

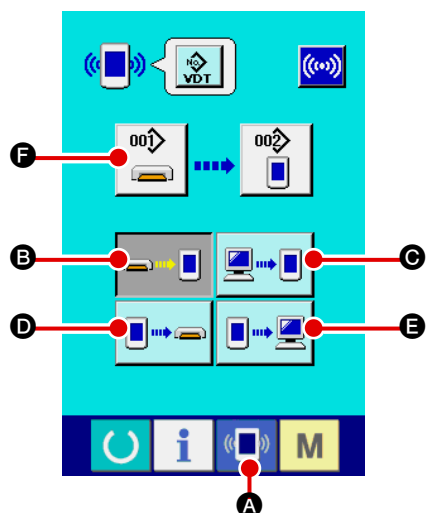

##### ① Display the communication screen.

When communication switch  (A) of switch seat section is pressed in the data input screen, the communication screen is displayed.

##### ② Select the communication procedure.

There are four communication procedures as described below.

- ⓑ Writing data from media to panel
- ⓒ Writing data from personal computer (server) to panel
- ⓓ Writing data from panel to media
- ⓔ Writing data from panel to personal computer (server)

Select the button of communication procedure you desire.

##### ③ Select the data No.

When  (F) is pressed, the writing file selection screen is displayed.

Input the file No. of the data you desire to write. For the file No., input the numerals of the part xxx of VD00xxx .vdt of the file name.

Designation of the pattern No. of writing destination can be performed in the same way. When the writing destination is the panel, pattern Nos. which have not been registered are displayed.

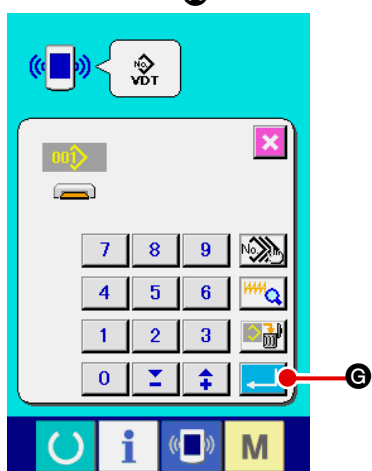



##### ④ Determine the data No.

When ENTER button  (G) is pressed, the data No. selection screen is closed and the selection of the data No. has been completed.

##### ⑤ Start communication.

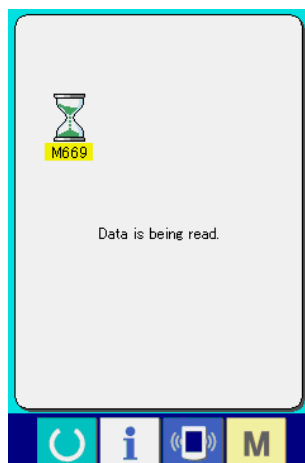
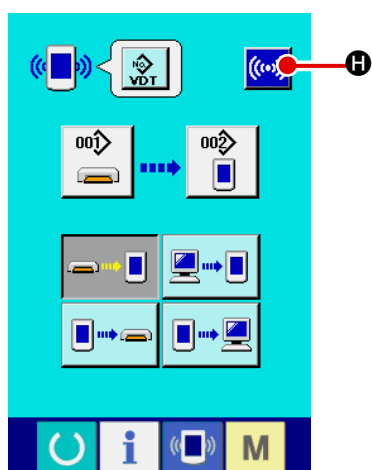
When COMMUNICATION START button  (H) is pressed, the data communication starts. The during communication screen is displayed during communication and the screen returns to the communication screen after the end of communication.



 **Do not open the cover during reading the data. Data may not be read in.**

## (5) Taking in plural data together

It is possible for vector data, M3 data and sewing standard format data to select plural writing data and write them together. Pattern No. of writing destination will become the same No. of the selected data No.

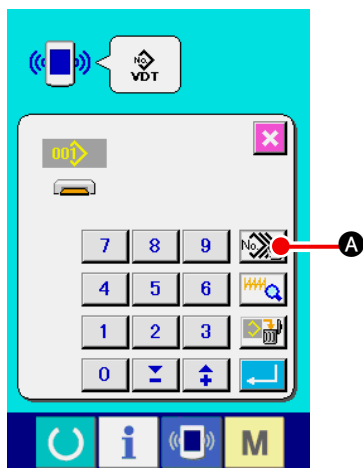

### ① Display the writing file selection screen.

When PLURAL SELECTION button  **A** is pressed, the data No. plural selection screen is displayed.

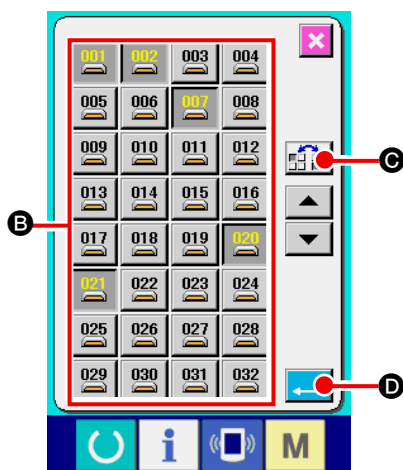

### ② Perform the data No. selection.

Since the list of existing data file numbers is displayed, press FILE NO. button **B** you desire to write. It is possible to invert the selected state of the button with INVERSION button  **C**.

### ③ Determine the data No.

When ENTER button  **D** is pressed, the data No. plural selection screen is closed and the data selection ends.

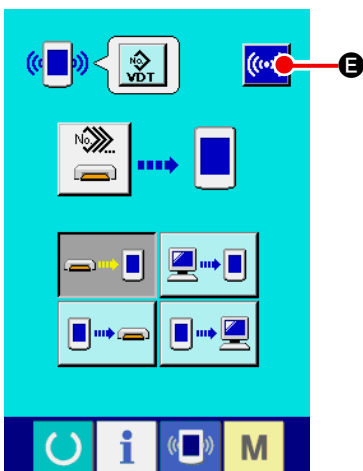

### ④ Start the communication.

When COMMUNICATION START button  **E** is pressed, the data communication starts.

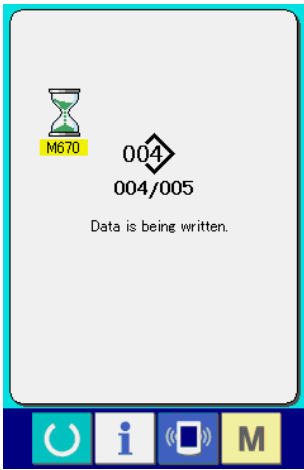

Data No. during communication, total number of writing data and number of data that have ended the data communication are displayed in the during communication screen.

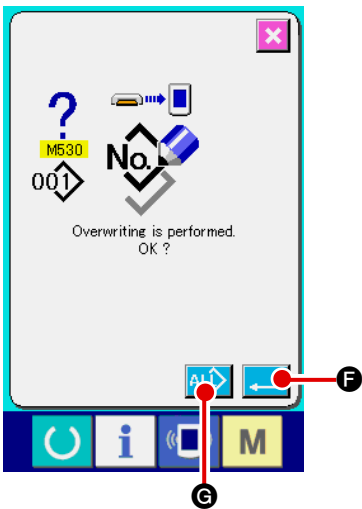

\* When performing writing to the pattern No. which already exists, the overwriting confirmation screen is displayed before writing. When performing overwriting, press ENTER button



When performing overwriting all without displaying the overwriting confirmation screen, press OVERWRITING button

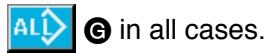

## 2-28. Performing formatting of the media

To re-format a medium, the IP-420 has to be used. The IP-420 is not able to read any medium which is formatted on a personal computer.

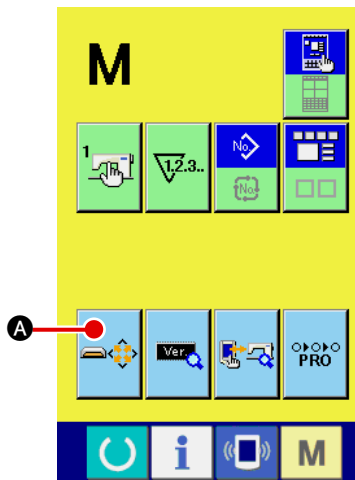

### ① Display the media format screen.

When **M** switch is held pressed for three seconds, MEDIA

FORMAT button  **A** is displayed on the screen. When

this button is pressed, the media format screen is displayed.

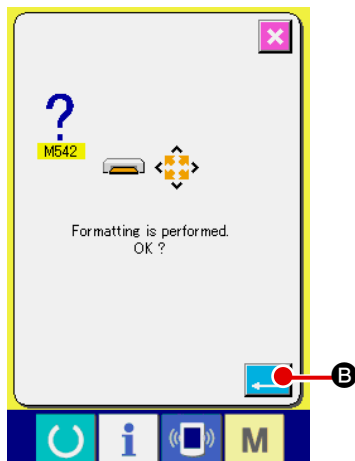

### ② Start formatting of the media.

Set the media you desire to format to the media slot, close

the cover, press ENTER button  **B** and formatting starts.

Save necessary data in the media to the other media before formatting. When formatting is performed, the inside data are deleted.

When two or more media are connected to the sewing machine, the medium to be formatted is determined by the predetermined priority order.

High ← Low

CF(TM) slot ← USB device 1 ← USB device 2 ← ....



When a CompactFlash (TM) is inserted in the CF(TM) slot, the CompactFlash (TM) will be formatted according to the priority order as shown above.

Refer to the USB specifications for the priority order of access.

## 2-29. Operation at the time of X/Y motor position slip

When X/Y motor detects the position slip, the error screen is displayed.

Timing of error display can be changed with the selection of memory switch. For the details, refer to the Engineer's Manual.

### (1) When the error is displayed during sewing

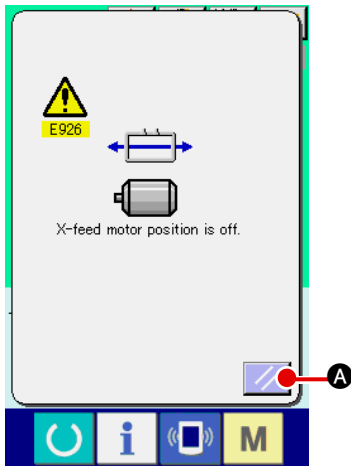

#### ① Release the error.

Press RESET button  **A** to release the error and the thread trimming pop-up is displayed.

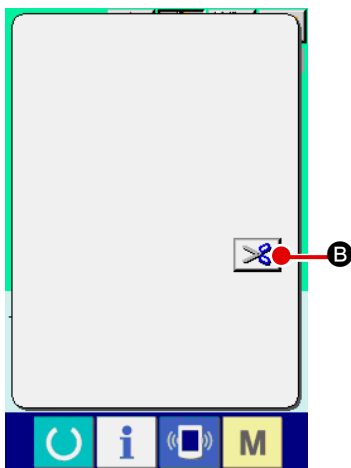

#### ② Perform thread trimming.



When it seems to be no problem after checking the stitches, depress the start pedal without change and re-start the sewing.

If not, press THREAD TRIM button  **B** and perform thread trimming.

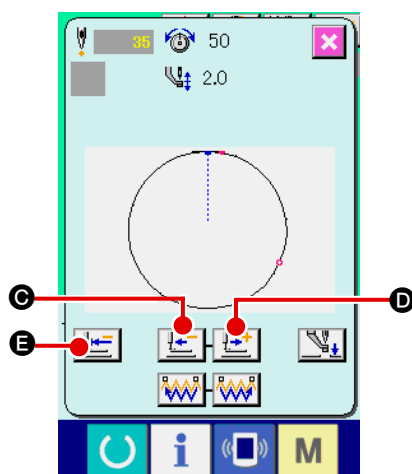
When performing thread trimming, the feed forward/back pop-up is displayed.



#### ③ Adjust the presser to the re-sewing position.

Every time FEED BACK button  **C** is pressed, the presser returns by one stitch. Every time FEED FORWARD button  **D** is pressed, the presser moves forward by one stitch. Move the presser up to the re-sewing position.

In addition, when RETURN TO ORIGIN button  **E** is pressed, the pop-up is closed, the sewing screen is displayed, and the presser returns to the sewing start position.

#### ④ Re-start sewing.

When the pedal is depressed, sewing starts again.

## (2) When the error is displayed after end of sewing

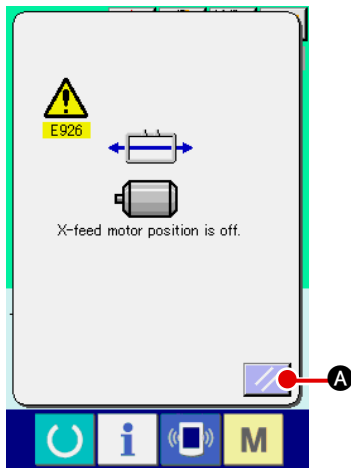

### ① Release the error.

When RESET button  **A** is pressed, and the error is released, the sewing screen is displayed.

### ② Perform sewing work again from the start.

When the pedal is depressed, sewing starts.

## (3) When the rest switch is not displayed

When a large slip is detected, the reset switch is not displayed.

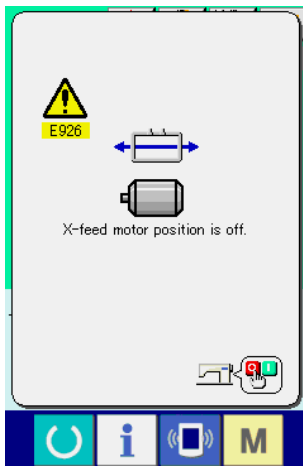











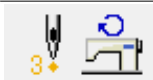

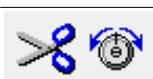

### ① Turn OFF the power.









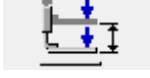

### 3. MEMORY SWITCH DATA LIST

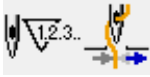















Memory switch data are the motion data that the sewing machine has in common and the data that operate on all sewing patterns in common.



#### 3-1. Data list







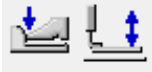











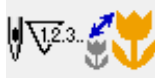

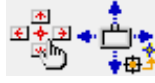

No.	Item		Setting range	Edit unit
U001	Maximum sewing speed		200 to 2800	100 sti/min
U002	Sewing speed of 1st stitch In case of with thread clamp		200 to 900	100 sti/min
U003	Sewing speed of 2nd stitch In case of with thread clamp		200 to 2800	100 sti/min
U004	Sewing speed of 3rd stitch In case of with thread clamp		200 to 2800	100 sti/min
U005	Sewing speed of 4th stitch In case of with thread clamp		200 to 2800	100 sti/min
U006	Sewing speed of 5th stitch In case of with thread clamp		200 to 2800	100 sti/min
U007	Thread tension of 1st stitch In case of with thread clamp		0 to 200	1
U008	Thread tension setting at the time of thread trimming		0 to 200	1
U009	Thread tension changeover timing at the time of thread trimming		- 6 to 4	1
U010	Sewing speed of 1st stitch In case of without thread clamp		200 to 1500	100 sti/min
U011	Sewing speed of 2nd stitch In case of without thread clamp		200 to 2800	100 sti/min
U012	Sewing speed of 3rd stitch In case of without thread clamp		200 to 2800	100 sti/min
U013	Sewing speed of 4th stitch In case of without thread clamp		200 to 2800	100 sti/min
U014	Sewing speed of 5th stitch In case of without thread clamp		200 to 2800	100 sti/min
U015	Thread tension of 1st stitch In case of without thread clamp		0 to 200	1
U016	Thread tension changeover timing at the time of sewing start In case of without thread clamp		- 5 to 2	1

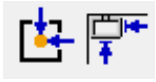

No.	Item	Setting range	Edit unit
U018	<b>Counter motion selection</b>  Sewing counter      No. of pcs. counter      Bobbin counter	---	---
U026	<b>Height of eight of presser at the time of 2 step stroke</b> 	10 to 300	1
U032	<b>Buzzer sound can be prohibited.</b>  Without buzzer sound      Panel operating sound      Panel operating sound + error	---	---
U033	<b>Number of stitches of thread clamp release is set.</b> 	1 to 7	1
U034	<b>Clamping timing of thread clamp can be delayed.</b> 	- 10 to 0	1
U035	<b>Thread clamp control can be prohibited.</b>  Normal      Prohibited	---	---
U036	<b>Feed motion timing is selected.</b> Set the timing in “-” direction when stitch is not well-tightened. 	- 8 to 16	1
U037	<b>State of the presser after end of sewing is selected.</b>  Presser goes up after moving at start of sewing.      Presser goes up immediately after end of sewing.      Presser goes up by pedal operation after moving at start of sewing.	---	---
U038	<b>Presser lifting motion at the end of sewing can be set.</b>  With presser up      Without presser up	---	---
U039	<b>Origin retrieval can be performed every time after end of sewing (other than combination sewing)</b>  Without origin retrieval      With origin retrieval	---	---
U040	<b>Origin retrieval in combination sewing can be set.</b>  Without origin retrieval      Every time 1 pattern is finished.      Every time 1 cycle is finished.	---	---
U041	<b>State of presser when sewing machine stops by temporary stop command can be selected.</b>  Presser rise.      Presser rise with presser switch.	---	---



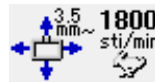

No.	Item	Setting range	Edit unit
U042	<b>Needle stop position is set.</b>  UP position  Upper dead point	---	---
U046	<b>Thread trimming can be prohibited.</b>  Normal  Thread trimming prohibited	---	---
U048	<b>Route of return to origin by return to origin button can be selected.</b>  Linear return  Reverse return of pattern  Origin retrieval → Sewing start point	---	---
U049	<b>Bobbin winding speed can be set.</b> 	800 to 2000	100 sti/min
U051	<b>Motion method of wiper can be selected.</b>  Invalid  Magnet typewiper	---	---
U064	<b>Unit of sewing shape size change can be selected.</b>  %input  Actual size input	---	---
U068	<b>Thread tension output time when setting thread tension can be set.</b> 	0 to 20	1
U069	<b>Bend position of thread clamp is selected.</b> 0 : S type 1 : H type thin thread (#50 to #8) 2 : H type intermediate 3 : H type thick thread (#5 to #2) 	---	---
U070	<b>Thread clamp and thread clamp position selection</b>  Front position  Rear position	---	---
U071	<b>Thread breakage detection selection</b>  Thread breakage detection invalid  Thread breakage detection valid	---	---
U072	<b>Number of invalid stitches at the start of sewing of thread breakage detection</b> 	0 to 15 stitches	1 stitch
U073	<b>Number of invalid stitches during sewing of thread breakage detection</b> 	0 to 15 stitches	1 stitch























No.	Item	Setting range	Edit unit
U081	<p><b>Feeding frame control : pedal open/close</b></p> <p>Operation order of feeding frame by pedal operation at the normal time is set.</p>  <p>0 : Solid presser  1 : Right/left separated presser (Without priority of right/left)  2 : Right/left separated presser (In the order of right to left)  3 : Right/left separated presser (In the order of left to right)  4 to 7 : Special type (*1)  8 : Solid presser  9 : Solid presser 2-step stroke  10 : Right/left separated presser 2-step stroke (Without priority of right/left)  11 : Right/left separated presser 2-step stroke (Order of right to left)  12 : Right/left separated presser 2-step stroke (Order of left to right)  13 to 99 : Solid presser  *1 : When using these items, refer to Engineer's Manual.</p>	0 to 99	1
U082	<p><b>Feeding frame control : midway stop time open/close</b></p> <p>Operation order of feeding frame by pedal operation when lifting the feeding frame by the temporary stop command in the pattern data is set.</p>  <p>0 : Solid presser  1 : Right/left separated presser (Without priority of right/left)  2 : Right/left separated presser (In the order of right to left)  3 : Right/left separated presser (In the order of left to right)  4 to 7 : Special type (*1)  8 : Solid presser  9 : Solid presser 2-step stroke  10 : Right/left separated presser 2-step stroke (Without priority of right/left)  11 : Right/left separated presser 2-step stroke (Order of right to left)  12 : Right/left separated presser 2-step stroke (Order of left to right)  13 to 99 : Solid presser  *1 : When using these items, refer to Engineer's Manual.</p>	0 to 99	1

No.	Item	Setting range	Edit unit
U084	<b>Pedal SW1 with/without latch</b>  Without  With	---	---
U085	<b>Pedal SW2 with/without latch</b>  Without  With	---	---
U086	<b>Pedal SW3 with/without latch</b>  Without  With	---	---
U087	<b>Pedal SW4 with/without latch</b>  Without  With	---	---
U088	<b>Enlarging/reducing function mode</b>  Prohibited  Increasing/decreasing number of stitches (Pitch is fixed.)  Increasing/decreasing pitch (Number of stitches is fixed.)	---	---
U089	<b>Jog move function mode</b>  Prohibited  Parallel move  2nd origin specified later	---	---
U091	<b>Retainer compensation motion : selection of motion</b>  Without motion  With motion	---	---
U094	<b>Selection of needle upper dead point at the time of origin retrieval/return to origin</b>  Without  With	---	---
U097	<b>Temporary stop : thread trimming operation</b>  Automatic thread trimming  Manual (Thread trimming by turning Stop SW ON again)	---	---
U101	<b>Main motor X/Y feed synchronized control : speed/pitch</b>  2800 sti/min/ 3.5mm  2200 sti/min/ 3.5mm  1800 sti/min/ 3.5mm  1400 sti/min/ 3.5mm	---	---









No.	Item	Setting range	Edit unit
<b>U103</b>	<b>Intermediate presser with/without control</b> Without (Lowering fixed) With (Lowering with sewing data at the time of operation) With (Lowering even at the time of feed forward/backward)	---	---
<b>U104</b>	<b>Intermediate presser lowering timing</b> Immediately before start-up of machine head Synchronized with the last feeding frame	---	---
<b>U105</b>	<b>Intermediate presser : wiper sweeping position</b> Sweeping above intermediate presser Sweeping above intermediate presser (position where intermediate presser lowers most) Sweeping below intermediate presser	---	---
<b>U108</b>	<b>With/without air pressure detection</b> Without With	---	---
<b>U112</b>	<b>Intermediate presser DOWN position setting</b> → Refer to <b>" I -4-7. Intermediate presser height" p.13.</b>	0 to 7.0mm	0.1
<b>U129</b>	<b>With/without needle cooler control</b> Without With	---	---
<b>U245</b>	<b>Grease-up error</b> Clearing of number of stitches of grease-up is performed. → Refer to <b>"Ⅲ-1-8. Replenishing the designated places with grease" p.107.</b>	---	---
<b>U500</b>	<b>Language selection</b> <input type="checkbox"/> 日本語 <input type="checkbox"/> English <input type="checkbox"/> 中文繁體字 <input type="checkbox"/> 中文简体字 <input type="checkbox"/> Japanese <input type="checkbox"/> English <input type="checkbox"/> Chinese (traditional) <input type="checkbox"/> Chinese (simplified) <input type="checkbox"/> Español <input type="checkbox"/> Italiano <input type="checkbox"/> Français <input type="checkbox"/> Deutsch <input type="checkbox"/> Spanish <input type="checkbox"/> Italian <input type="checkbox"/> French <input type="checkbox"/> German <input type="checkbox"/> Português <input type="checkbox"/> Türkçe <input type="checkbox"/> Tiếng Việt <input type="checkbox"/> 한국어 <input type="checkbox"/> Portuguese <input type="checkbox"/> Turkish <input type="checkbox"/> Vietnamese <input type="checkbox"/> Korean <input type="checkbox"/> Indonesia <input type="checkbox"/> Русский <input type="checkbox"/> Indonesian <input type="checkbox"/> Russian		

### 3-2. Initial value list

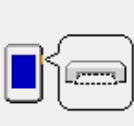







No.	Item	Initial value		
		HS 2516/3020	SL/HL 2516	SL/HL 2516 FU06
U001	Maximum sewing speed	2800		
U002	Sewing speed of 1st stitch (In case of with thread clamp)	900		
U003	Sewing speed of 2nd stitch (In case of with thread clamp)	2800		
U004	Sewing speed of 3rd stitch (In case of with thread clamp)	2800		
U005	Sewing speed of 4th stitch (In case of with thread clamp)	2800		
U006	Sewing speed of 5th stitch (In case of with thread clamp)	2800		
U007	Thread tension of 1st stitch (In case of with thread clamp)	200		
U008	Thread tension setting at the time of thread trimming	0		
U009	Thread tension changeover timing at the time of thread trimming	0		
U010	Sewing speed of 1st stitch (In case of without thread clamp)	200		
U011	Sewing speed of 2nd stitch (In case of without thread clamp)	600		
U12	Sewing speed of 3rd stitch (In case of without thread clamp)	1000		
U013	Sewing speed of 4th stitch (In case of without thread clamp)	1500		
U014	Sewing speed of 5th stitch (In case of without thread clamp)	2000		
U015	Thread tension of 1st stitch (In case of without thread clamp)	0		
U016	Thread tension changeover timing at the time of sewing start (In case of without thread clamp)	-5		
U018	Counter motion selection			
U026	Height of eight of presser at the time of 2 step stroke	70		
U032	Buzzer sound can be prohibited.			
U033	Number of stitches of thread clamp release is set.	2		
U034	Clamping timing of thread clamp can be delayed.	0		
U035	Thread clamp control can be prohibited.			
U036	Feed motion timing is selected.	3		
U037	State of the presser after end of sewing is selected.			
U038	Presser lifting motion at the end of sewing can be set.			
U039	Origin retrieval can be performed every time after end of sewing (other than combination sewing).			
U040	Origin retrieval in combination sewing can be set.			
U041	State of presser when sewing machine stops by temporary stop command can be selected.			
U042	Needle stop position is set.			



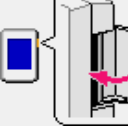



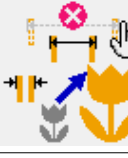

No.	Item	Initial value		
		HS 2516/3020	SL/HL 2516	SL/HL 2516 FU06
U046	Thread trimming can be prohibited.			
U048	Route of return to origin by return to origin button can be selected.			
U049	Bobbin winding speed can be set.		1600	
U051	Motion method of wiper can be selected.			
U064	Unit of sewing shape size change can be selected.			
U068	Thread tension output time when setting thread tension can be set.		20	
U069	Bend position of thread clamp is selected.		S type : 0 / H type : 1	
U070	Thread clamp and thread clamp position selection			
U071	Thread breakage detection selection			
U072	Number of invalid stitches at the start of sewing of thread breakage detection		8	
U073	Number of invalid stitches during sewing of thread breakage detection		3	
U081	Feeding frame control : pedal open/close	0	5	6
U082	Feeding frame control : midway stop time open/close	0	5	6
U084	Pedal SW1 with/without latch			
U085	Pedal SW2 with/without latch			
U086	Pedal SW3 with/without latch			
U087	Pedal SW4 with/without latch			
U088	Enlarging/reducing function mode			
U089	Jog move function mode			
U091	Retainer compensation motion : selection of motion			
U094	Selection of needle upper dead point at the time of origin retrieval/return to origin			
U097	Temporary stop : thread trimming operation			
U101	Main motor X/Y feed synchronized control : speed/pitch			
U103	Intermediate presser with/without control			
U104	Intermediate presser lowering timing			
U105	Intermediate presser : wiper sweeping position			
U108	With/without air pressure detection			
U112	Intermediate presser DOWN position setting		3.5	
U129	With/without needle cooler control			
U245	Grease-up error		-	
U500	Language selection		Not set	



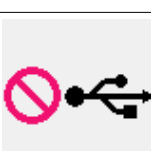



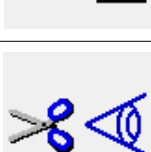

## 4. ERROR CODE LIST





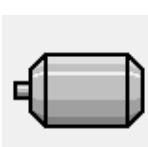

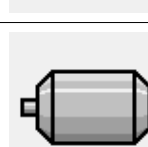
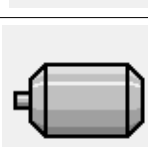

Error code	Display	Description of error	Display message	How to recover	Place of recovery
E007		<b>Machine lock</b> Main shaft of the sewing machine fails to rotate due to some trouble	Machine is locked.	Turn OFF the power	
E008		<b>Head connector abnormality</b> Memory of machine head cannot be read.	Undefined head is selected.	Turn OFF the power	
E010		<b>Pattern No. error</b> Pattern No. which is backed up is not registered to data ROM, or setting of reading inoperative is performed.	Specified pattern does not exist.	Possible to re-enter after reset.	Previous screen
E011		<b>External media not inserted</b> External media is not inserted.	Media is not inserted.	Possible to re-enter after reset.	Previous screen
E012		<b>Read error</b> Data read from external media cannot be performed.	Data cannot be read.	Possible to re-start after reset.	Previous screen
E013		<b>Write error</b> Data write from external media cannot be performed.	Data cannot be written.	Possible to re-start after reset.	Previous screen
E015		<b>Format error</b> Format cannot be performed.	Formatting is impossible.	Possible to re-start after reset.	Previous screen
E016		<b>External media capacity over</b> Capacity of external media is short.	Capacity is insufficient. (media)	Possible to re-start after reset.	Previous screen
E017		<b>Machine memory capacity over</b> Machine memory capacity is insufficient.	Capacity is insufficient. (Machine)	Possible to re-start after reset.	Previous screen
E019		<b>File size over</b> File is too large.	Pattern data is too large. (Approx. 50000 stitches)	Possible to re-start after reset.	Previous screen

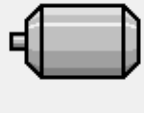
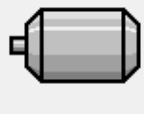



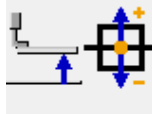

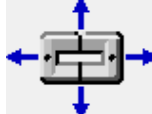



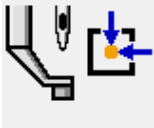
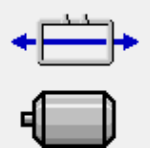
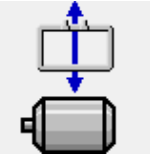

Error code	Display	Description of error	Display message	How to recover	Place of recovery
E024		<b>Pattern data size over</b> Memory size is over.	Memory capacity has run out.	Possible to re-start after reset.	Data input screen
E027		<b>Read error</b> Data read from server cannot be performed.	Data cannot be read.	Possible to re-start after reset.	Previous screen
E028		<b>Write error</b> Data write from server cannot be performed.	Data cannot be written.	Possible to re-start after reset.	Previous screen
E029		<b>Media slot release error</b> Lid of media slot is open.	Cover of media slot is open.	Possible to re-start after reset.	Previous screen
E030		<b>Needle bar position missing error</b> Needle bar is not in the predetermined position.	Needle is not in a proper position.	Turn hand pulley to bring needle bar to its predetermined position.	Data input screen
E031		<b>Air pressure drop</b> Air pressure is dropped.	Low air pressure.	Possible to re-start after reset.	Data input screen
E032		<b>File interchanging error</b> File cannot be read.	File cannot be read.	Possible to re-start after reset.	Data input screen
E040		<b>Sewing area over</b>	Move limit is exceeded.	Possible to re-start after reset.	Sewing screen
E043		<b>Enlarging error</b> Sewing pitch exceeds Max. pitch.	Max. Pitch is exceeded.	Possible to re-start after reset.	Data input screen
E045		<b>Pattern data error</b>	Pattern data no good.	Possible to re-start after reset.	Data input screen
E050		<b>Stop switch</b> When stop switch is pressed during machine running.	Temporary stop switch is pressed.	Possible to re-start after reset.	Step screen

Error code	Display	Description of error	Display message	How to recover	Place of recovery
E052		<b>Thread breakage detection error</b> When thread breakage is detected.	Thread breakage is detected.	Possible to re-start after reset.	Step screen
E061		<b>Memory switch data error</b> Memory switch data is broken or revision is old.	Memory switch data error.	Turn OFF the power	
E204		<b>USB connection error</b> With the number of times of sewing has reached 10 or more, with a USB device connected to the sewing machine	Never connect USB storage device to the machine during sewing.	Possible to re-start after reset.	Sewing screen
E220		<b>Grease-up warning</b> At the time of operation of 100 million stitches → Refer to " <b>III-1-8 Replenishing the designated places with grease</b> " p.107.	Important: Grease is running out. Add grease.	Possible to re-start after reset.	Data input screen
E221		<b>Grease-up error</b> At the time of operation of 120 million stitches The sewing machine is put in the sewing-impossible status. It is possible to clear with memoryswitch <b>U245</b> . → Refer to " <b>III-1-8 Replenishing the designated places with grease</b> " p.107.	Important: Grease has run out. Add grease.	Possible to re-start after reset.	Data input screen
E302		<b>Head tilt confirmation</b> When head tilt sensor is OFF.	Head is tilted.	Possible to re-start after reset.	Previous screen
E305		<b>Cloth cutting knife position error</b> Cloth cutting knife is in the regular position.	Thread trimmer knife sensor cannot be detected.	Turn OFF the power	Data input screen
E306		<b>Thread clamp position error</b> Thread clamp unit is not in the regular position.	Thread clamp sensor cannot be detected.	Turn OFF the power	
E307		<b>External input command time out error</b> Input is not performed for a fixed period of time with the external input command of vector data.	There is no input for a certain period of time with external input command of vector data.	Possible to re-start after reset.	Data input screen

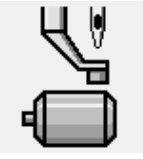
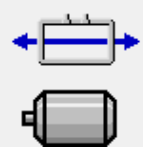
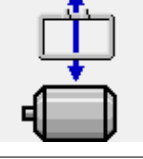









Error code	Display	Description of error	Display message	How to recover	Place of recovery
E308		<b>Time-out error of wait terminal</b> There is no input to wait terminal for a certain period of time.	There is no input from wait terminal for a certain period of time.	Turn OFF the power	
E703		<b>Panel is connected to the sewing machine which is not supposed. (Machine type error)</b> When the machine type code of system is not proper in the initial communication.	Model of sewing machine is different from that of panel.	Possible to rewrite program after pressing down communication switch.	Communication screen
E704		<b>Inconsistency of system version</b> System software version is inconsistent in the initial communication.	Version of program incompatible.	Possible to rewrite program after pressing down communication switch.	Communication screen
E730		<b>Main shaft motor encoder defectiveness</b> When encoder of the sewing machine motor is abnormal.	Sewing machine motor is defective. (Encoder A and B phases)	Turn OFF the power	
E731		<b>Main motor hole sensor is defective or position sensor is defective.</b> Hole sensor or position sensor of the sewing machine motor is defective.	Sewing machine motor is defective. (Encoder U V and W phases)	Turn OFF the power	
E733		<b>Reverse rotation of main shaft motor</b> When sewing machine motor rotates in reverse direction.	Sewing machine motor runs in the reverse direction.	Turn OFF the power	
E802		<b>Power electrical discontinuity detection</b>	Power instantaneously lost.	Turn OFF the power	
E811		<b>Overvoltage</b> When input power is more than the specified value.	Input voltage is too high. (Check input voltage.)	Turn OFF the power	
E813		<b>Low voltage</b> When input power is less than the specified value.	Input voltage is too low. (Check input voltage.)	Turn OFF the power	
E901		<b>Main shaft motor IPM abnormality</b> When IPM of servo control p.c.b. is abnormal.	SDC P.C.B. is defective. (IPM)	Turn OFF the power	

Error code	Display	Description of error	Display message	How to recover	Place of recovery
E903		<b>Stepping motor power abnormality</b> When stepping motor power of SERVO CONTROL p. c. b. fluctuates more than $\pm 15\%$ .	Power of SDC P.C.B. is defective. (Stepping motor power 85 V)	Turn OFF the power	
E904		<b>Solenoid power abnormality</b> When solenoid power of SERVO CONTROL p. c. b. fluctuates more than $\pm 15\%$ .	Power of SDC P.C.B. is defective. (Solenoid power 33 V)	Turn OFF the power	
E905		<b>Heat sink temperature for SERVO CONTROL p. c. b. abnormality</b> Turn ON the power again after taking overheat time of SERVO CONTROL p. c. b.	Temperature of SDC P.C.B. is too high.	Turn OFF the power	
E907		<b>X feed motor origin retrieval error</b> When origin sensor signal is not inputted at the time of origin retrieval motion.	Origin of X motor cannot be found. (X origin sensor)	Turn OFF the power	
E908		<b>Y feed motor origin retrieval error</b> When origin sensor signal is not inputted at the time of origin retrieval motion.	Origin of Y motor cannot be found. (Y origin sensor)	Turn OFF the power	
E910		<b>Presser motor origin retrieval error</b> When origin sensor signal is not inputted at the time of origin retrieval motion.	Origin of presser thread trimmer motor cannot be found. (Presser thread trimmer origin sensor)	Turn OFF the power	
E913		<b>Thread clamp origin retrieval error</b> When origin sensor signal is not inputted at the time of origin retrieval motion.	Origin of thread clamp motor cannot be found. (Thread clamp origin sensor)	Turn OFF the power	
E914		<b>Feed defective error</b> Timing lag between feed and main shaft occurs.	X/Y feed trouble is detected.	Turn OFF the power	
E915		<b>Communication abnormality between operation panel and MAIN CPU</b> When abnormality occurs in data communication.	Communication is impossible. (Panel - MAIN P.C.B.)	Turn OFF the power	
E916		<b>Communication abnormality between MAIN CPU and main shaft CPU</b> When abnormality occurs in data communication.	Communication is impossible. (MAIN P.C.B. - SDC P.C.B.)	Turn OFF the power	

Error code	Display	Description of error	Display message	How to recover	Place of recovery
E917		<b>Communication failure between operation panel and personal computer</b> When abnormality occurs in data communication.	Communication is impossible. (Panel - PC)	Possible to re-start after reset.	
E918		<b>MAIN p. c. b. overheat</b> Overheat of MAIN p. c. b. Turn ON the power again after taking time.	Main P.C.B. temperature is too high.	Turn OFF the power	
E925		<b>Intermediate presser motor origin retrieval error</b> Origin sensor of intermediate presser motor does not change at the time of origin retrieval.	Origin of intermediate presser cannot be found. (Intermediate presser origin sensor)	Turn OFF the power	
E926		<b>X motor position slip error</b>	X-feed motor position is off.	<ol style="list-style-type: none"> <li>In case of error display during sewing Possible to re-start after reset</li> <li>In case of error display after end of sewing Possible to re-start after reset</li> <li>In case of others Turn OFF the power.</li> </ol>	<ol style="list-style-type: none"> <li>Step screen</li> <li>Sewing screen</li> <li>-----</li> </ol>
E927		<b>Y motor position slip error</b>	Y-feed motor position is off.	<ol style="list-style-type: none"> <li>In case of error display during sewing Possible to re-start after reset</li> <li>In case of error display after end of sewing Possible to re-start after reset</li> <li>In case of others Turn OFF the power.</li> </ol>	<ol style="list-style-type: none"> <li>Step screen</li> <li>Sewing screen</li> <li>-----</li> </ol>





Error code	Display	Description of error	Display message	How to recover	Place of recovery
E928		<b>Thread trimming motor position slip error</b>	Thread trimming motor position is off.	Turn OFF the power	
E930		<b>Intermediate presser motor position slip error</b>	Intermediate presser motor position is off.	Turn OFF the power	
E931		<b>X motor overload error</b>	X-feed motor overload is excessive.	Turn OFF the power	
E932		<b>Y motor overload error</b>	Y-feed motor overload is excessive.	Turn OFF the power	
E933		<b>Thread trimming motor overload error</b>	Thread trimming motor overload is excessive.	Turn OFF the power	
E935		<b>Intermediate presser motor overload error</b>	Intermediate presser motor overload is excessive.	Turn OFF the power	
E936		<b>X/Y motor out of range error</b>	Feed motor position has exceeded the sewing area.	Turn OFF the power	
E943		<b>MAIN CONTROL p.c.b. trouble</b> When data writing to MAIN CONTROL p.c.b. cannot be performed	MAIN P.C.B. is defective.	Turn OFF the power	
E946		<b>HEAD RELAY p.c.b. trouble</b> When data writing to HEAD RELAY p.c.b. cannot be performed	Head P.C.B. is defective.	Turn OFF the power	

## 5. MESSAGE LIST

Message No.	Display	Display message	Description
M520		Erasing is performed. OK ?	<b>Erase confirmation of Users' pattern</b> Erase is performed. OK ?
M521		Erasing is performed. OK ?	<b>Erase confirmation of pattern button</b> Erase is performed. OK ?
M522		Erasing is performed. OK ?	<b>Erase confirmation cycle pattern</b> Erase is performed. OK ?
M523		Pattern data is not stored. Erasing is OK?	<b>Erase confirmation of backup data</b> Pattern data is not stored in memory. Erase is OK ?
M528		Overwriting is performed. OK ?	<b>Overwriting confirmation of users' pattern</b> Overwriting is performed. OK ?
M529		Overwriting is performed. OK ?	<b>Overwriting confirmation of media</b> Overwriting is performed. OK ?
M530		Overwriting is performed. OK ?	<b>Overwriting confirmation of vector data of panel/M3 data/sewing standard format data/simplified program data</b> Overwriting is performed. OK ?
M531		Overwriting is performed. OK ?	<b>Overwriting confirmation of vector data of media/M3 data/sewing standard format data/simplified program data</b> Overwriting is performed. OK ?
M532		Overwriting is performed. OK ?	<b>Overwriting confirmation of vector data on personal computer/M3 data/sewing standard format data/simplified program data</b> Overwriting is performed. OK ?
M534		Overwriting is performed. OK ?	<b>Overwriting confirmation of adjustment data of media and all machine data</b> Overwriting is performed. OK ?

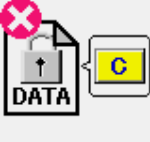
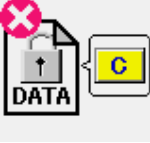
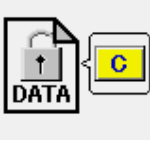
Message No.	Display	Display message	Description
M535		Overwriting is performed. OK ?	<b>Overwriting confirmation of adjustment data on personal computer and all machine data</b> Overwriting is performed. OK ?
M537		Deleting is performed. OK ?	<b>Deletion confirmation of thread tension command</b> Deleting is performed. OK ?
M538		Deleting is performed. OK ?	<b>Deletion confirmation of intermediate presser increase/decrease value</b> Deleting is performed. OK ?
M542		Formatting is performed. OK ?	<b>Format confirmation</b> Formatting is performed. OK ?
M544		Data does not exist.	<b>Data corresponding to panel does not exist.</b> Data does not exist.
M545		Data does not exist.	<b>Data corresponding to media does not exist.</b> Data does not exist.
M546		Data does not exist.	<b>Data corresponding to personal computer does not exist.</b> Data does not exist.
M547		Overwriting cannot be performed since data exists.	<b>Overwriting prohibition on pattern data</b> Overwriting cannot be performed since data exists.
M548		Overwriting cannot be performed since data exists.	<b>Overwriting prohibition on media data</b> Overwriting cannot be performed since data exists.
M549		Overwriting cannot be performed since data exists.	<b>Overwriting prohibition on data on personal computer</b> Overwriting cannot be performed since data exists.
M550		There is back-up data of body input.	<b>Backup data information on main body input</b> There is back-up data of body input.



Message No.	Display	Display message	Description
M554		Key-lock customization data have been initialized.	<b>Customized data initialization notice</b> Customized key-lock data has been initialized.
M555		Key-lock customization data are broken. Initializing is OK?	<b>Customized data breakage</b> Customized key-lock data has broken. Initialization is performed. OK?
M556		Key-lock customization data are to be initialized. OK?	<b>Initialization confirmation of customized data</b> Customized key-lock data is initialized. OK?
M653		Formatting is performed.	<b>During formatting</b> Formatting is performed.
M669		Data is being read.	<b>During data reading</b> Data is being read.
M670		Data is being written.	<b>During data writing</b> Data is being written.
M671		Data is being converted.	<b>During data converting</b> Data is being converted.

# III. MAINTENANCE OF SAWING MACHINE

## 1. MAINTENANCE

### 1-1. Adjusting the height of the needle bar (Changing the length of the needle)



**WARNING :**

Turn OFF the power before starting the work so as to prevent accidents caused by abrupt start of the sewing machine.

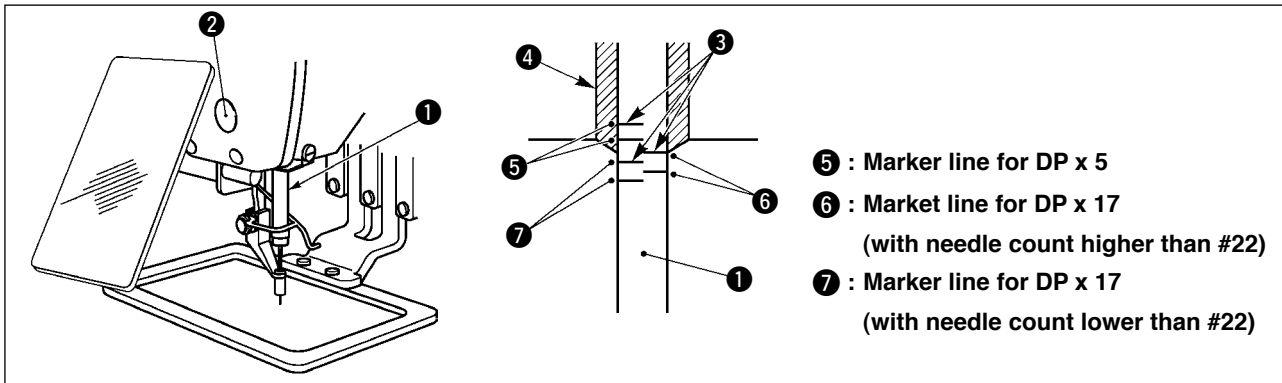

\* Turn ON the power once, and turn OFF the power again after making the intermediate presser in the lowered state.

- 1) Bring needle bar ① down to the lowest position of its stroke. Loosen needle bar connection screw ② and adjust so that the upper marker line ③ engraved on the needle bar aligns with the bottom end of the needle bar bushing lower ④.
- 2) As illustrated in the above figure, change the adjusting position in accordance with the needle count.



After the adjustment, turn the pulley to check for an extra load.

### 1-2. Adjusting the needle-to-shuttle relation



**WARNING :**

Turn OFF the power before starting the work so as to prevent accidents caused by abrupt start of the sewing machine.

Relation between the needle and the marker lines on the needle bar

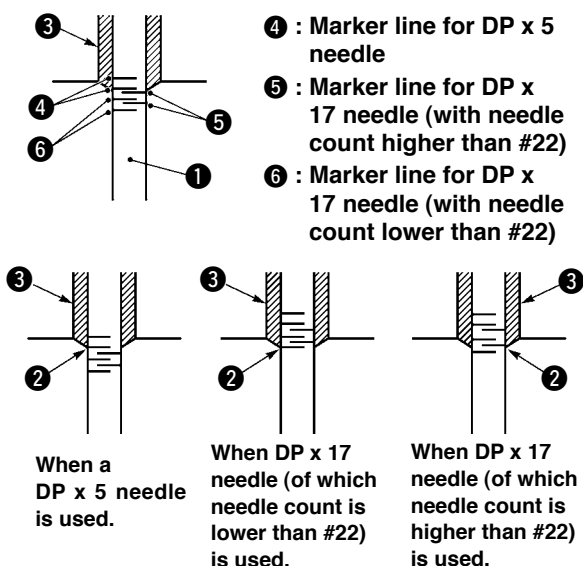

\* Turn ON the power once, and turn OFF the power again after making the intermediate presser in the lowered state.

- 1) Turn handwheel by hand to ascend the needle bar ①.  
Adjust so that lower marker line ② on the ascending needle bar aligns with the bottom end of the needle bar bushing lower.

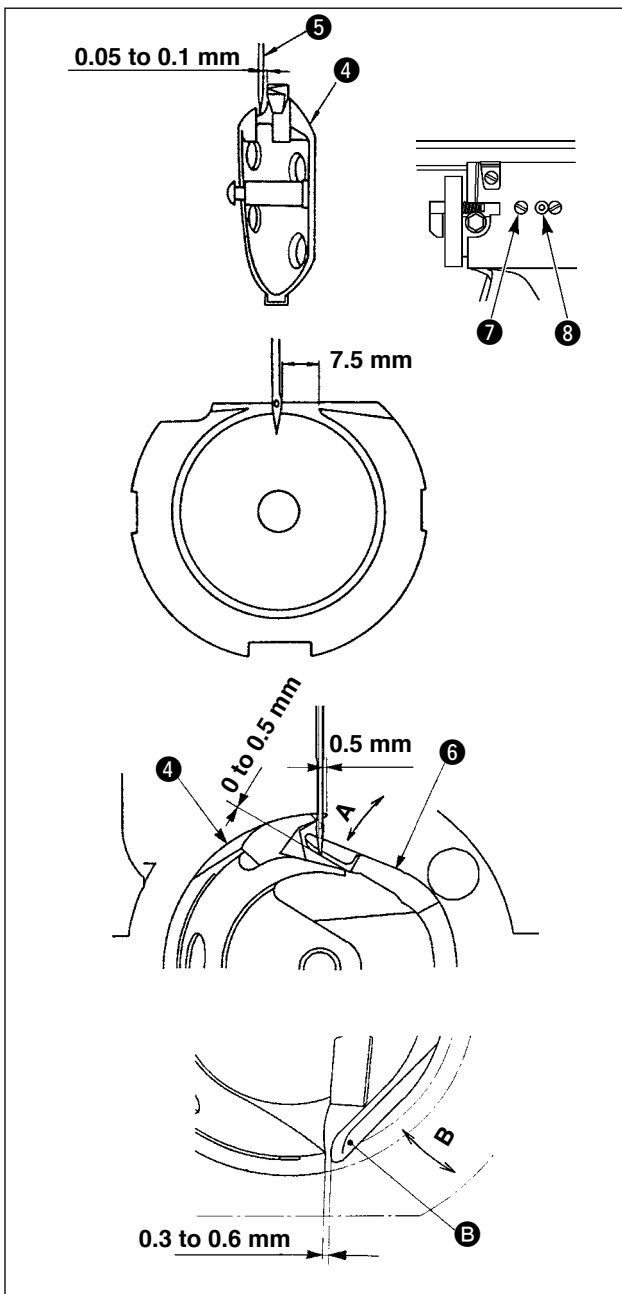
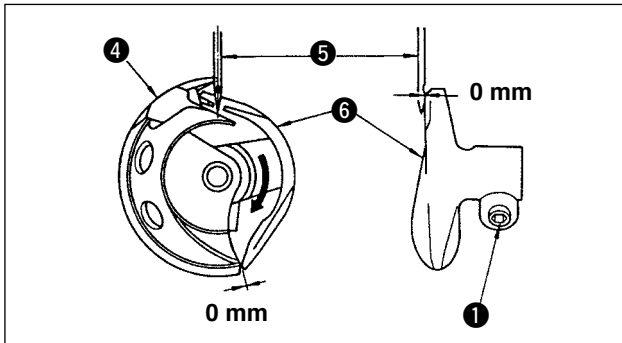
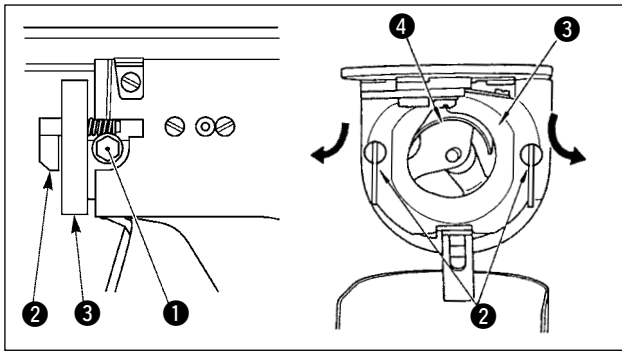

- Loosen setscrew ① in the driver. Drawing bobbin case opening lever hook ② toward you, open it to the right and left until bobbin case opening lever ③ comes off.

**Caution** At this time, be careful not to let shuttle ④ come off and fall.

- Adjust so that the point of shuttle ④ meets the center of needle ⑤, and that a clearance of 0 mm is provided between the front end face of driver ⑥ and needle as the front end face of driver receives needle to prevent the needle from being bent. Then tighten setscrew ①.
- Loosen shuttle race screw ⑦, and adjust the longitudinal position of the shuttle race. To do this adjustment, turn shuttle race adjusting shaft ⑧ clockwise or counterclockwise to provide a 0.05 to 0.1 mm clearance between needle ⑤ and the blade point of shuttle ④.
- After adjusting the longitudinal position of shuttle race, further adjust to provide a 7.5 mm clearance between the needle and the shuttle race. Then, tighten screw ⑦ of shuttle race.
- When changing the number of needle from the number at the time of standard delivery or using a new driver, perform the adjustment of the height of driver.

#### [Adjustment of height of driver]

- Adjust so that the blade point of inner hook ④ meets the center of needle ⑤ and tighten setscrew ①.
- Bend the needle guard section of driver ⑥ in the direction of arrow A so that the protruding amount from the bottom end of the needle guard section of driver ⑥ to the tip of needle ⑤ is 0 to 0.5 mm when the blade point of inner hook ④ is out by 0.5 mm from the right end of needle ⑤.
- Bend rear end B of driver ⑥ in the direction B so that the clearance between rear end B of driver ⑥ and inner hook ④ is 0.3 to 0.6 mm.
- Perform adjustment of steps 3) to 5) above.

**1. When making the needle size thicker, confirm the clearance between the needle tip or the intermediate presser and the wiper. Wiper cannot be used unless the clearance is secured. In this case, turn OFF the wiper switch, or change the set value of memory switch U105.**

**2. When the height of the needle guard of the driver is not proper, abrasion of the blade point of inner hook or stitch skipping will be caused.**

### 1-3. Adjusting the height of the feeding frame



**WARNING :**

Turn OFF the power before starting the work so as to prevent accidents caused by abrupt start of the sewing machine.

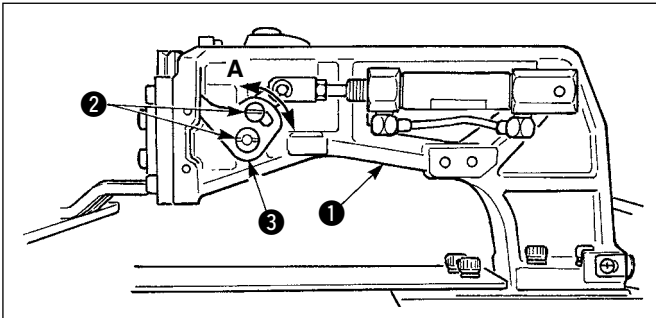

- 1) Loosen setscrews ② located on the right and left sides of feed bracket ①. Moving cloth presser link ③ to the direction A will decrease the height of the feeding frame.
- 2) After the adjustment of the height of the feeding frame, securely tighten the screws ②.

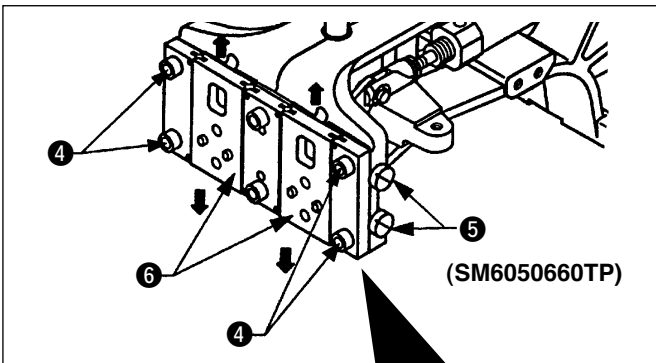

If the feeding frame still interferes with the bearing and the feeding frame height does not change after the adjustment of the position of work clamp link, adjust the pressure applied to the bearing to lower it as far as no lateral play of the feeding frame occur. At the time of delivery, work clamp foot has been moved up and down to adjust the torque (sliding torque) of bearing ⑦ to 0.98 to 7.84 N (100 to 800 g) applied when work clamp foot starts moving after bearing ⑦ has come in contact with the spring pin.

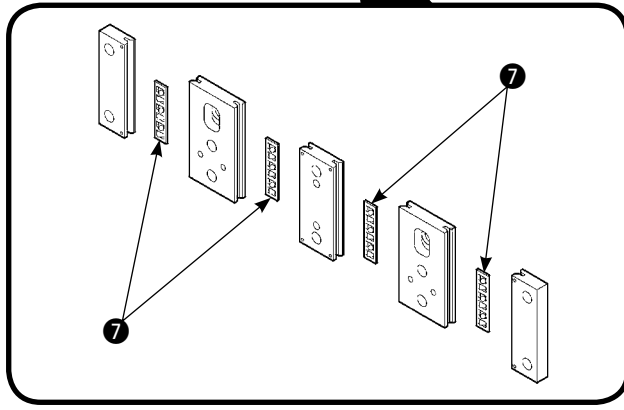

1. Loosen the setscrew ④.
2. Lightly tighten the pressure adjusting screw ⑤ and give a pressure to the bearing ⑦. At that time, move the slide plate ⑥ vertically, making sure that uneven application of torque can be avoided.
3. Tighten the setscrew ④.



1. When the setscrew ④ is tightened, pressure kept applied to the bearing ⑦ is changed.

Therefore, when the setscrew ④ is tightened, examine the amount of the slippage torque.

2. The pressure adjusting screw ⑤ is not attached to the sewing machine.

### 1-4. Adjusting the vertical stroke of the intermediate presser



**WARNING :**

Turn OFF the power before starting the work so as to prevent accidents caused by abrupt start of the sewing machine.

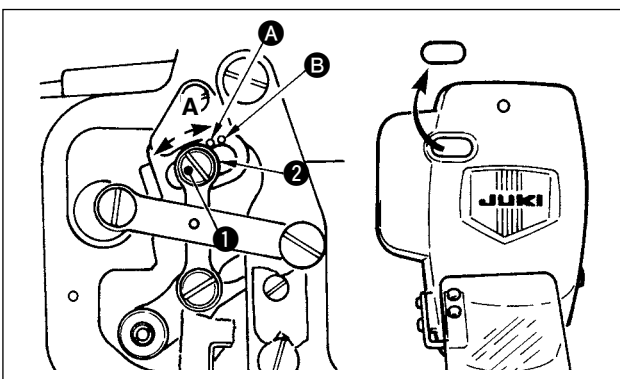

\* Turn ON the power once, and turn OFF the power again after making the intermediate presser in the lowered state.

- 1) Remove face cover.
- 2) Turn handwheel to make the needle bar come down to its lowest point.
- 3) Loosen hinge screw ① and move it to the direction A to increase the stroke.
- 4) When marker dot A is aligned with the right side of the outer periphery of washer ②, the vertical stroke of the intermediate presser becomes 4 mm. And, when marker dot B is aligned with the right side of the outer periphery of the washer, it becomes 7 mm. (The vertical stroke of the intermediate presser is factory-set to 4 mm at the time of delivery.)



By removing the rubber plug in the face plate cover, adjustment can be performed without removing the face plate cover.

## 1-5. The moving knife and counter knife



### WARNING :

Turn OFF the power before starting the work so as to prevent accidents caused by abrupt start of the sewing machine.

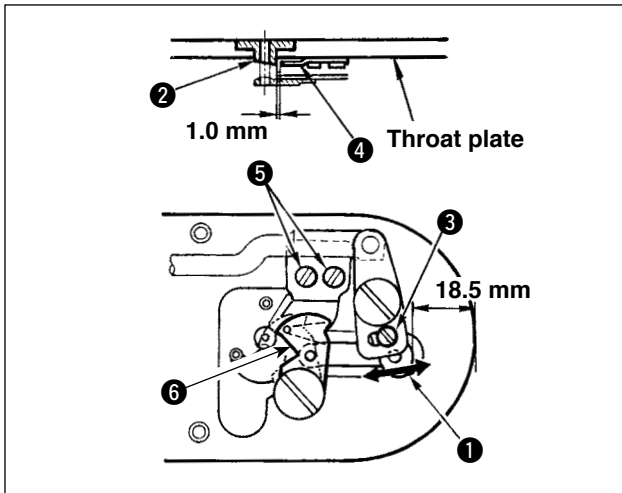

- 1) Loosen adjusting screw ① so that a clearance of 18.5 mm is provided between the front end of the throat plate and the top end of thread trimmer lever, small ③. To adjust, move the moving knife in the direction of arrow.
- 2) Loosen setscrew ⑤ so that a clearance of 1.0 mm is provided between needle hole guide ② and counter knife ④. To adjust, move the counter knife.

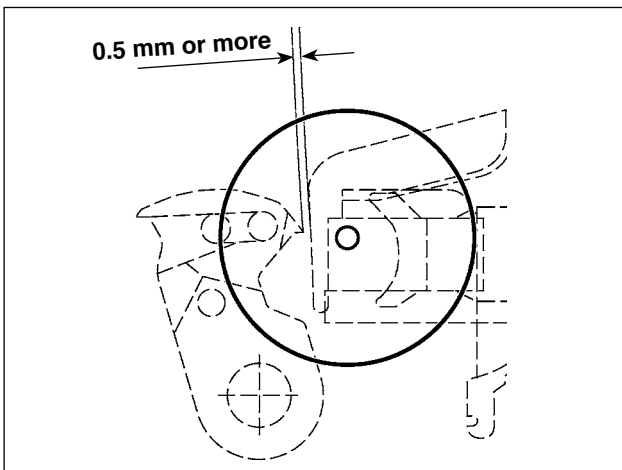

After the origin retrieval, press the SET READY key on the IP panel to verify that a clearance of 0.5 mm or more is provided between the top end of moving knife and the top end of needle thread clamp. If a clearance of 0.5 mm or more cannot be secured, adjust the position of moving knife within  $18.5 \pm 0.5$  mm to secure the specified clearance.



## 1-6. Needle thread clamp device



### WARNING :

Turn OFF the power before starting the work so as to prevent accidents caused by abrupt start of the sewing machine.

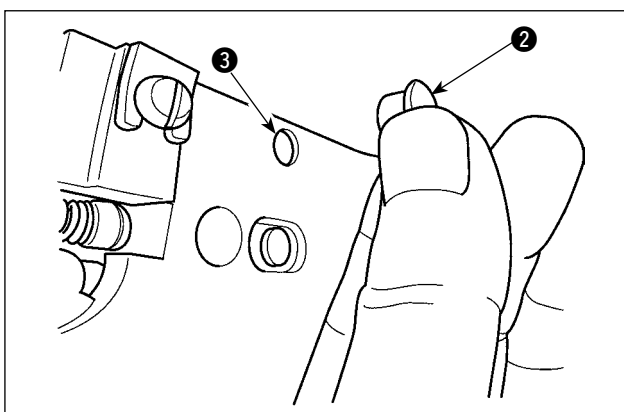
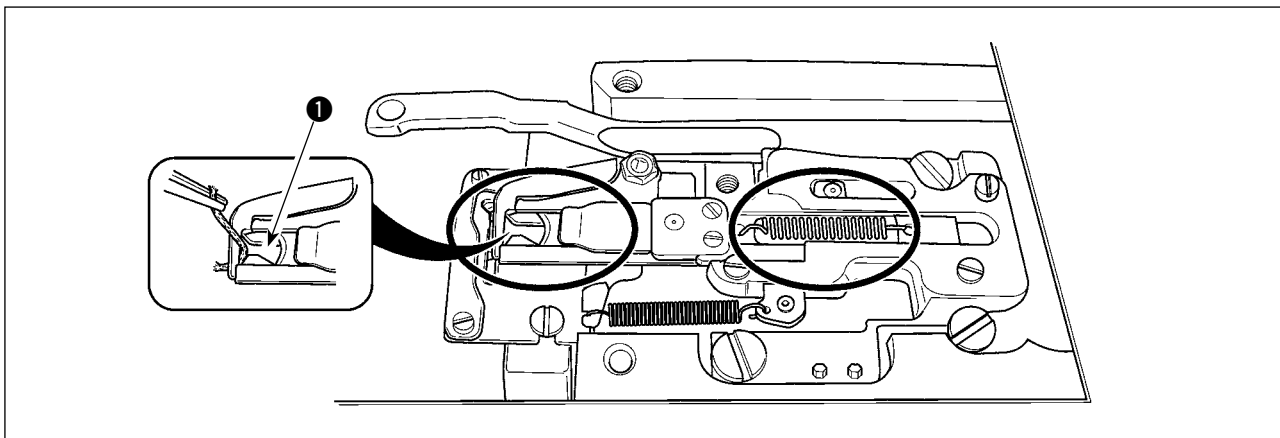

When thread is caught at top end **1** of the thread clamp, thread clamp becomes incomplete and sewing trouble at the sewing start will be caused. Thread waste and lint are likely to accumulate in the sections which are shown in the circles. The sections should therefore be periodically cleaned by removing the throat plate and by blowing air through hole **3** by removing rubber plug **2**.

## 1-7. Thread breakage detector plate

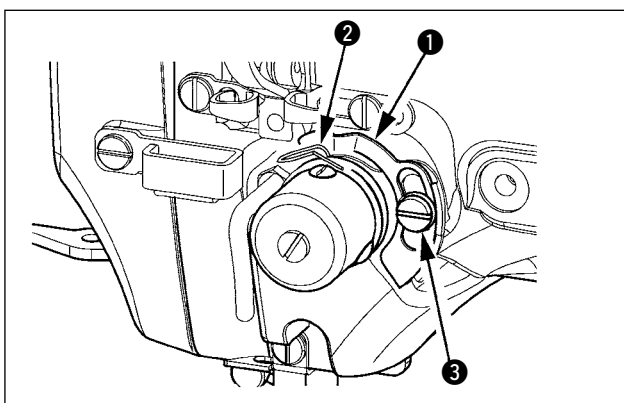

- 1) Adjust so that thread breakage detector plate **1** is always in contact with thread take-up spring **2** in the absence of needle thread. (Slack : approx. 0.5 mm)
- 2) Whenever the stroke of thread take-up spring **2** has been changed, be sure to readjust thread breakage detector plate **1**. To make this adjustment, loosen screw **3**.



**Adjust so that thread breakage detector plate **1** does not touch any adjacent metallic parts other than thread take-up spring **2**.**

## 1-8. Replenishing the designated places with grease

- \* Perform grease supplement when the errors below are displayed or once a year (either one which is earlier).

If grease has decreased due to cleaning of the sewing machine or any other reasons, be sure to immediately add grease.

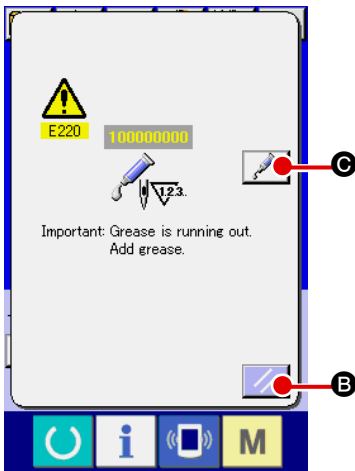

When the sewing machine has been used for a certain number of stitches, error "E220 Grease-up warning" is displayed. This display informs the operator of the time of replenishing the designated places with grease. Be sure to replenish the places with the grease below. Then call the memory switch U245, press CLEAR button

**C** **A** and set NUMBER OF STITCHES **D** to "0".

Even after the display of the error "E220 Grease-up warning", when RESET key  **B** is pressed, the error is released, and the sewing machine can be continuously used. Afterwards, however, error code "E220 Grease-up warning" is displayed every time the power is re-turning ON.

In addition, when the sewing machine is used further for a certain period of time without replenishing the places with grease after the display of error No. E220, error "E221 Grease-up error" is displayed and the sewing machine fails to operate since the error cannot be released even when the RESET key is pressed.

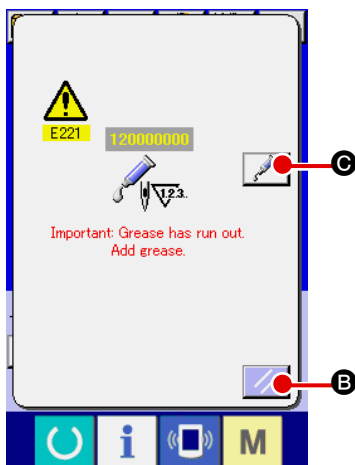

When error "E221 Grease-up error" is displayed, be sure to replenish the designated places below with grease. Then call the memory switch U245, press CLEAR button **C** **A** and set NUMBER OF STITCHES **D** to "0".

When RESET key  **B** is pressed without replenishing the designated places with grease, error code "E221 Grease-up warning" is displayed every time the power is re-turning ON afterwards and the sewing machine fails to operate. So, be careful.

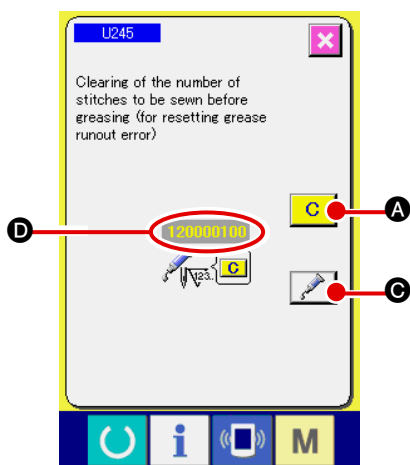

1. Error code E220 or E221 is displayed again unless NUMBER OF STITCHES **D** is changed to "0" after replenishing the designated places with grease. When E221 is displayed, the sewing machine fails to operate. So, be careful.



2. When GREASE APPLYING POSITION DISPLAY button  **C** is pressed in each screen, the grease applying position can be confirmed in the panel display. Be sure, however, to perform the grease applying after turning OFF the power.

## (1) Location where exclusive grease is provided

Two different types of JUKI Grease A ❶ and B ❷ and an exclusive coupling and setscrew for JUKI Grease B are provided at the location as shown in the illustration. Add grease periodically (when the grease runout warning No. E220 is displayed on the panel or once a year) to points to be applied with grease.

If grease has decreased due to cleaning of the sewing machine or any other reasons, be sure to immediately add grease.



**Do not use Grease A and Grease B with mixed. Be sure to use the specified grease without fail. The grease filling coupling and setscrew should be used when applying JUKI Grease B. They should not be used for JUKI Grease A.**

**JUKI Grease B ❷**

**JUKI Grease A ❶**

When the grease runs short, be sure to purchase new grease.

		Spare parts No.
JUKI Grease A	10g tube	40006323
	100g tube	23640204
JUKI Grease B	10g tube	40013640



### WARNING :

Turn OFF the power before starting the work so as to prevent accidents caused by abrupt start or the sewing machine. In addition, attach the covers which have been removed before operation back in place.

## (2) Points to be applied with JUKI Grease A



**Use grease tube A (part number: 40006323) (in light blue) supplied with the unit for adding grease to any points other than the points specified below. If any grease other than the specified one is used, the related components can be damaged.**

### ■ Adding grease to the oscillating rock shaft gear section

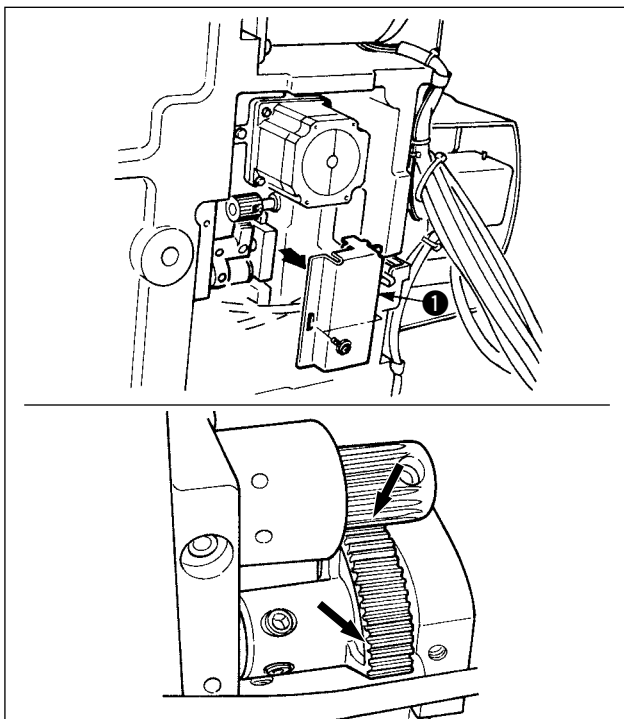

- 1) Tilt the sewing machine and remove grease cover ❶.
- 2) Apply JUKI Grease A onto the gear section of oscillating rock shaft and the periphery of the hook driving shaft.
- 3) Apply JUKI Grease A also onto the felt surface of grease cover ❶.



**If the grease has decreased due to cleaning, air blow or other reasons, apply grease again without exceptions.**

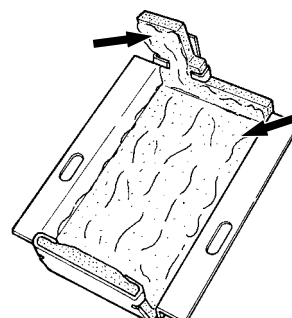



■ Adding grease to the needle bar upper and lower bushings section, slide block section and intermediate presser bar lower bushing section

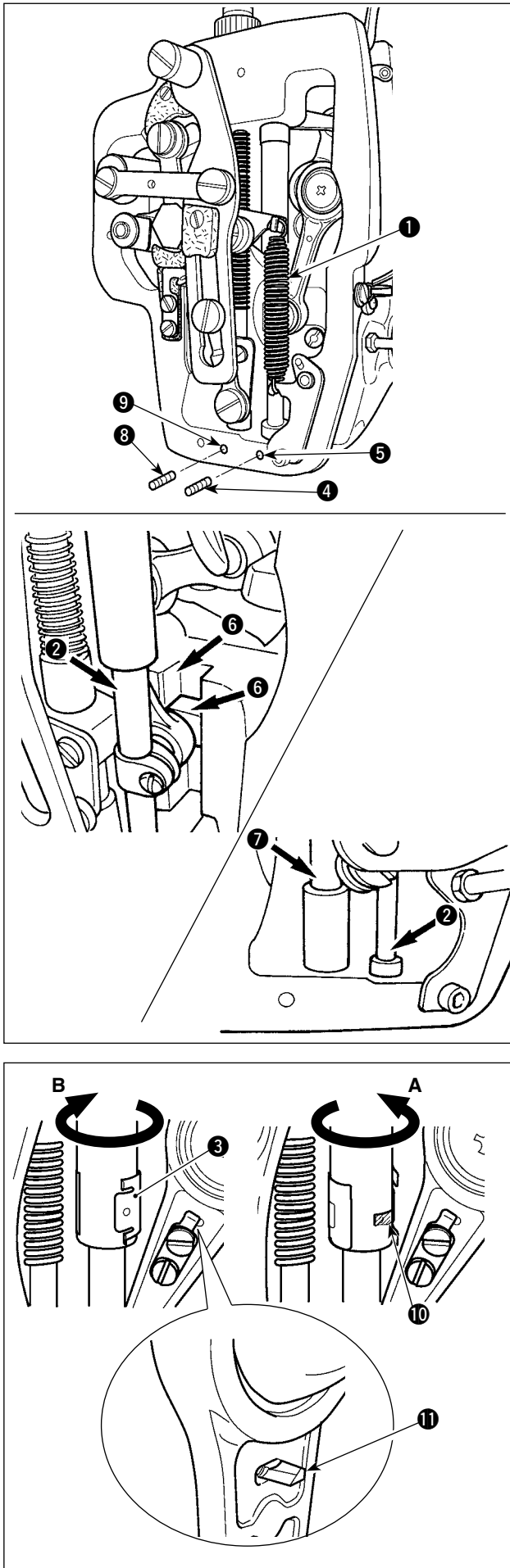

- 1) Open the frame cover to remove intermediate presser auxiliary spring B ①.
- 2) Apply JUKI Grease A onto periphery of needle bar ②. Turn the sewing machine by hand to apply grease onto the entire periphery of the needle bar.  
Turn needle bar upper bushing grease cover ③ in the direction of arrow A to add grease through the grease inlet. After completion of the procedure, turn the needle bar upper bushing grease cover in the direction of arrow B to return to its home position.  
Remove setscrew ④ from the needle bar lower bushing grease hole. Put JUKI Grease A through hole ⑤ and tighten setscrew ④ to fill inside the bushing with the grease.
- 3) Apply JUKI Grease A also onto groove section ⑥ of the slide block.
- 4) Apply JUKI Grease A onto periphery of intermediate presser bar ⑦.  
Remove setscrew ⑧ from the intermediate presser bar bushing grease hole. Put JUKI Grease A through inlet ⑨. Tighten screw ⑧ to fill inside the bushing with JUKI Grease A.

1. Do not wipe off the grease applied onto the periphery of needle bar inside the frame. If the grease has decreased due to cleaning, air blow or other reasons, apply grease again without exceptions.

2. When operating the sewing machine, turn the needle bar upper bushing grease cover in direction B to close grease inlet ⑩.

3. The rear face of the needle bar crank rod has projection ⑪ with a sharp edge. So, care should be taken to the projection. Never put your finger to the rear face of the needle bar crank rod during greasing procedure.



### (3) Points to be applied with JUKI Grease B



Use grease tube B (part number: 40013640) (in light violet) supplied with the unit for adding grease to any points other than the points specified below. If any grease other than the specified one is used, the related components can be damaged.

#### ■ Adding grease onto the eccentric cam section

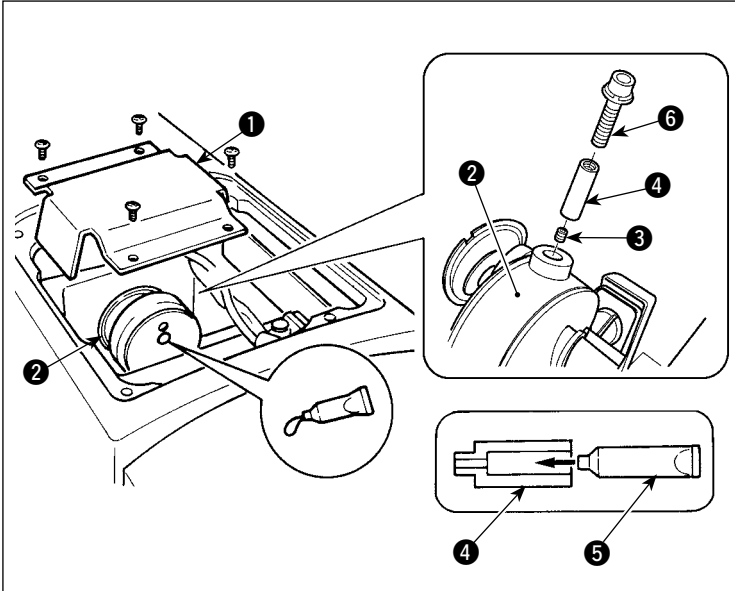

- 1) Open crank rod cover ①.
- 2) Remove setscrew ③ from the grease inlet cover located at periphery of crank rod ②.
- 3) Fill coupling ④ with grease through JUKI Grease B tube ⑤.
- 4) Sink screw ⑥ supplied with the unit into the coupling to add the grease.
- 5) After adding the grease, securely tighten setscrew ③ which has been removed.

The eccentric cam section can be sufficiently filled with grease by adding the grease while turning the main shaft of sewing machine.



#### ■ Adding grease onto the oscillating rock shaft pin section

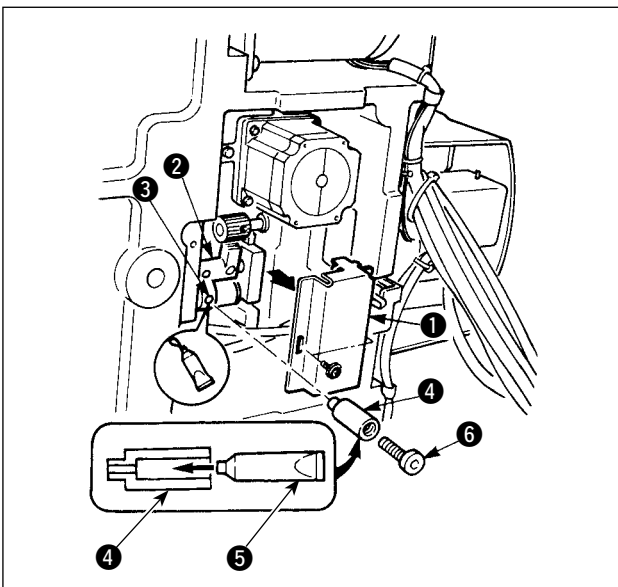

- 1) Tilt the machine head and remove the grease cover ①.
- 2) Fill coupling ④ supplied with the unit with grease through JUKI Grease B tube ⑤.
- 3) Remove setscrew ③ in oscillator gear ② and screw in joint ④ into the screw hole.
- 4) Sink screw ⑥ supplied with the unit into the coupling to add the JUKI Grease B.
- 5) Securely tighten setscrew ③ which has been removed after replenishing with the grease.

■ Grease supplement to the face plate section

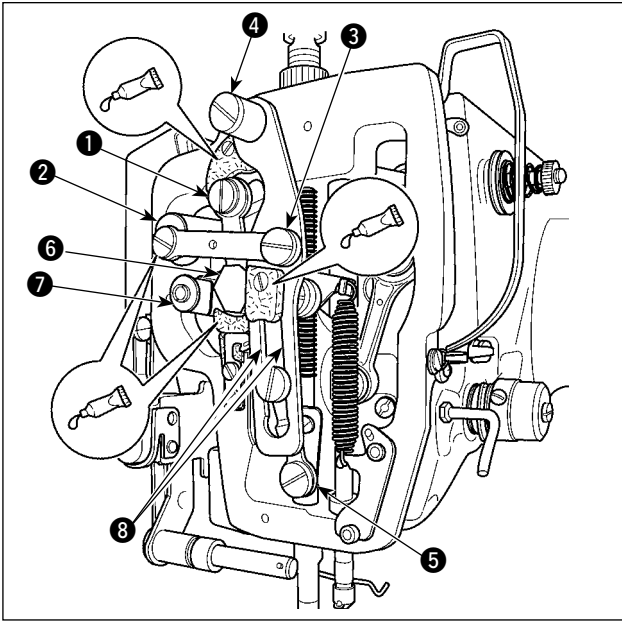

- 1) Open the face plate cover.
- 2) Add the JUKI Grease B onto the felt sections (3 locations), peripheral shoulder screw, fulcrums ① to ⑦ and guide groove section ⑧.

■ Replenishing the presser plate with grease

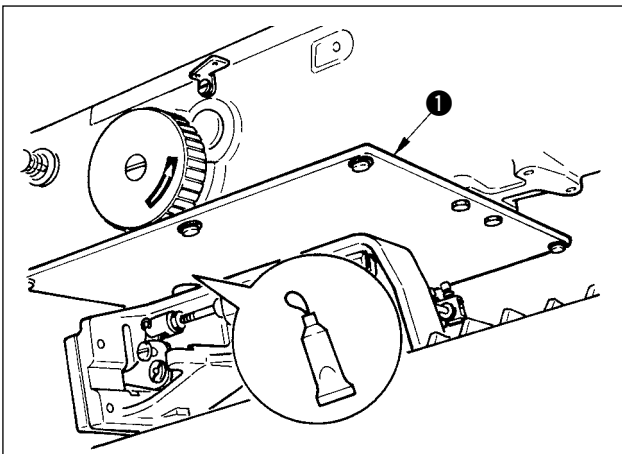

- 1) Apply grease to the rear of presser plate ①.

## 1-9. Draining waste oil

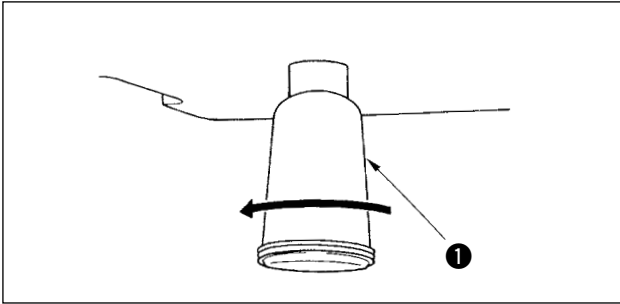

When polyethylene oiler ① becomes filled with oil, remove polyethylene oiler ① and drain the oil.

## 1-10. Amount of oil supplied to the hook

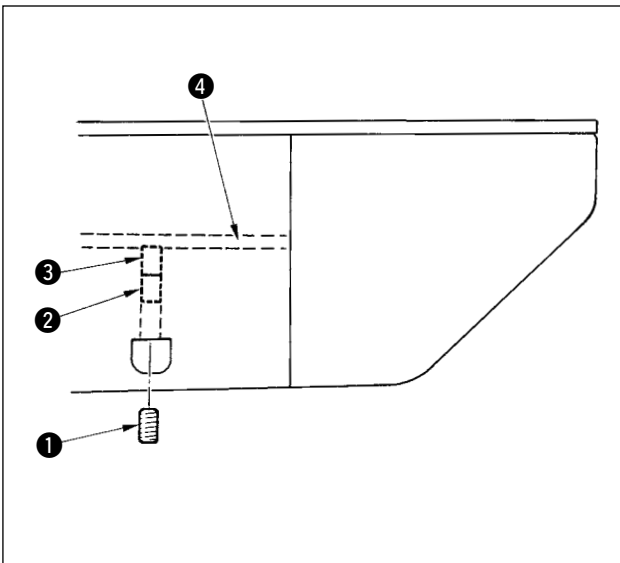

- 1) Loosen setscrew ① and remove setscrew ①.
- 2) When screwing in adjustment screw ②, the amount of oil of oil pipe, left ④ can be reduced.
- 3) After the adjustment, screw in setscrew ① and fix it.



1. The state of standard delivery is the position where ③ is lightly screwed in and returned by 4 turns.
2. When reducing the amount of oil, do not screw in the screw at once. Observe the state for approximately half a day at the position where ③ is screwed in and returned by 2 turns. If reducing is excessive, worn-out of the hook will result.

## 1-11. Replacing the fuse



### WARNING :

1. To avoid electrical shock hazards, turn OFF the power and open the control box cover after about five minutes have passed.
2. Open the control box cover after turning OFF the power without fail. Then, replace with a new fuse with the specified capacity.

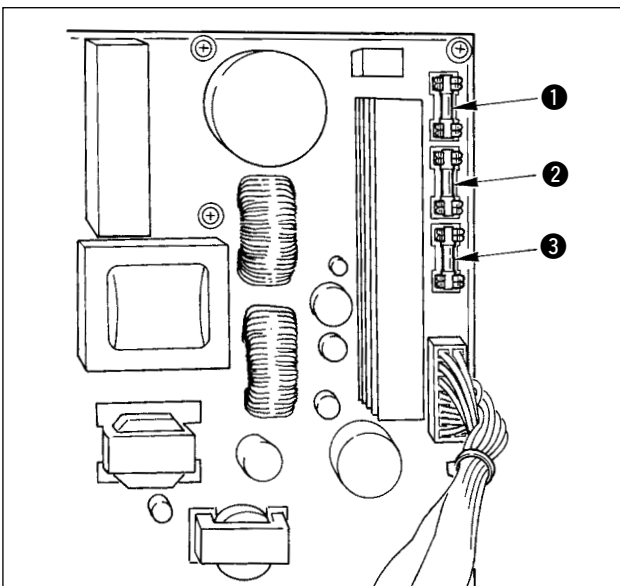

The machine uses the following three fuses :

- ① For pulse motor power supply protection  
15A (time-lag fuse)
- ② For solenoid and pulse motor power supply protection  
3.15A (time-lag fuse)
- ③ For control power supply protection  
2A (fast-blow type fuse)

## 1-12. Changing the voltage of 100 $\longleftrightarrow$ 200V



### WARNING :

To prevent personal injuries caused by electric shock hazards or abrupt start of the sewing machine, carry out the work after turning OFF the power switch and a lapse of 5 minutes or more. To prevent accidents caused by unaccustomed work or electric shock, request the electric expert or engineer of our dealers when adjusting the electrical components.

It is adaptable to the voltage of single phase 100V to 120V/3-phase 200V to 240V by changing the voltage changeover connector mounted on FLT p.c.b.

**(Caution)** When the changing procedure is wrong, the control box will be broken. So, be very careful.

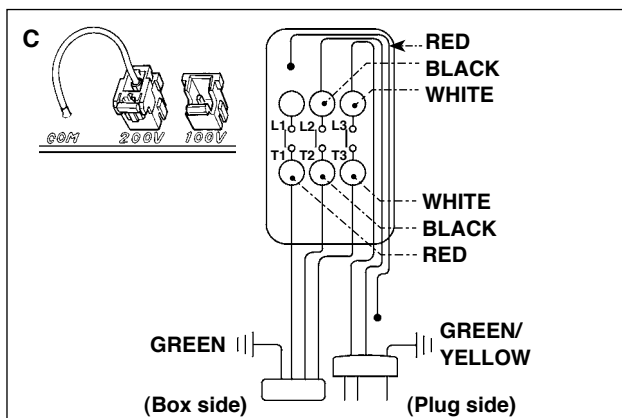
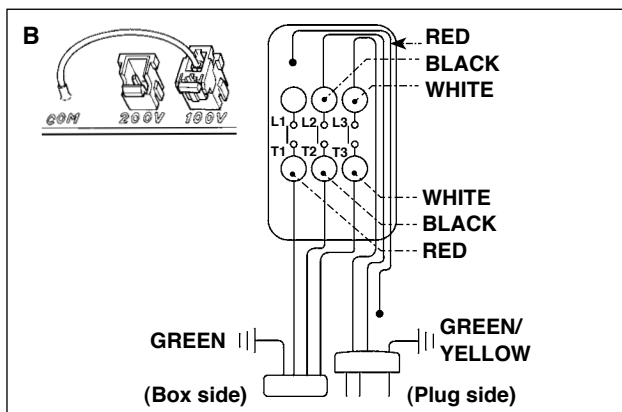
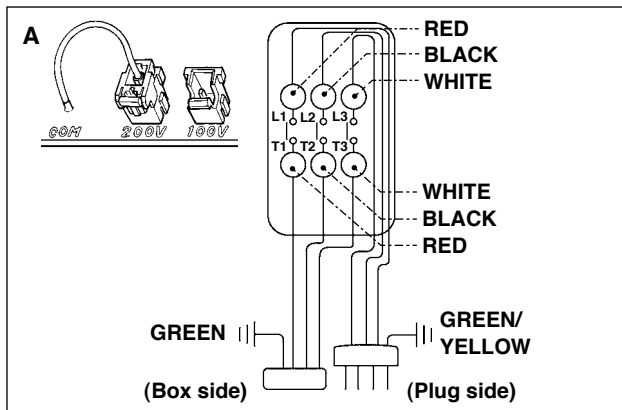
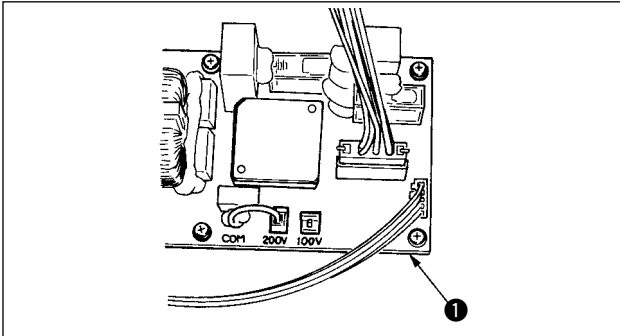

Changing procedure of the changeover connector

1. Turn OFF the power source with the power switch after confirming that the sewing machine has stopped.
2. Draw out the power cord from the power plug socket after confirming that the power switch is turned OFF. Then wait for five minutes or more.
3. Remove the front cover.
4. Remove four screws fixing the rear cover of the control box and slowly open the rear cover.

#### A. In case of using with 3-phase 200V to 240V

- Changing the changeover connector  
Connect to 200V the 100/200V changeover connector of FLT p.c.b. ❶ located on the side of the Box Side of the control box.
- Connect the crimp style terminal of AC input cord to the power plug as shown in the figure.

#### B. In case of using with single phase 100V to 120V

- Changing the changeover connector  
Connect to 100V the 100 $\rightarrow$ 200V changeover connector of FLT p.c.b. ❶ located on the side of the Box Side of the control box.
- Connect the crimp style terminal of AC input cord to the power plug as shown in the figure.

**(Caution)** Securely perform the insulation treatment to the red terminal which is not used with insulation tape or the like. (When the insulation is insufficient, there is a danger of electric shock or leakage current.)

#### C. In case of using with single phase 200V to 240V

- Changing the changeover connector  
Connect to 200V the 100 $\rightarrow$ 200V changeover connector of FLT p.c.b. ❶ located on the side of the Box Side of the control box.
- Connect the crimp style terminal of AC input cord to the power plug as shown in the figure.

**(Caution)** Securely perform the insulation treatment to the red terminal which is not used with insulation tape or the like. (When the insulation is insufficient, there is a danger of electric shock or leakage current.)

5. Check that the change has been performed without fail before closing the rear cover.
6. Be careful that the cord is not pinched between the rear cover and the control box main unit. Close the rear cover while pressing the lower side of rear cover, and tighten four screws.

## 1-13. Troubles and corrective measures (Sewing conditions)

Trouble	Cause	Corrective measures	Page
1. The needle thread slips off at the start of bartacking.	① Stitches are slipped at the start.	○ Adjust the clearance between the needle and the shuttle to 0.05 to 0.1 mm.	103
	② The needle thread remaining on the needle after thread trimming is too short.	○ Set soft-start sewing at the start of bartacking.	84
		○ Correct the thread tension release timing of the thread tension controller No. 2.	12,13
	③ The bobbin thread is too short.	○ Increase the tension of the thread take-up spring, or decrease the tension of the thread tension controller No. 1.	12
		○ Decrease the tension of the bobbin thread.	
	④ Needle thread tension at 1st stitch is too high.	○ Increase the clearance between the needle hole guide and the counter knife.	105
○ Decrease the tension at 1st stitch.			
⑤ Thread clamp is unstable (material is apt to be expanded, thread is hard to slide, thread is thick, etc.).	○ Decrease the number of rotation at 1st stitch at the sewing start. (Extent of 600 to 1,000 sti/min)		
⑥ Pitch at 1st stitch is too small.	○ Increase the number of stitches of thread clamp to 3 to 4 stitches.		
	○ Make the pitch at 1st stitch longer.		
	○ Decrease the needle thread tension at 1st stitch.		
2. Thread often breaks or synthetic fiber thread splits finely.	① The shuttle or the driver has scratches.	○ Take it out and remove the scratches using a fine whetstone or buff.	13
	② The needle hole guide has scratches.	○ Buff or replace it.	
	③ The needle strikes the intermediate presser foot.	○ Correct the position of the intermediate presser foot.	12
	④ Fibrous dust is in the groove of the shuttle race.	○ Take out the shuttle and remove the fibrous dust from the shuttle race.	
	⑤ The needle thread tension is too high.	○ Reduce the needle thread tension.	13
	⑥ The tension of the thread take-up spring is too high.	○ Reduce the tension.	
	⑦ The synthetic fiber thread melts due to heat generated on the needle.	○ Use silicone oil.	116
	⑧ When taking up thread, thread is pierced with needle tip.	○ Lower the needle bar height from the engraved marker line by a half of the line to as much as the line. ○ Check the rough state of needle tip. ○ Use the ball-pointed needle.	
3. The needle often breaks.	① The needle is bent.	○ Replace the bent needle.	11
	② The needle strikes the intermediate presser foot.	○ Correct the position of the intermediate presser foot.	13
	③ The needle is too thin for the material.	○ Replace it with a thicker needle according to the material.	103
	④ The driver excessively bends the needle.	○ Correctly position the needle and the shuttle.	
4. Threads are not trimmed.  (Bobbin thread only)	① The counter knife is dull.	○ Replace the counter knife.	105
	② The difference in level between the needle hole guide and the counter knife is not enough.	○ Increase the bend of the counter knife.	
	③ The moving knife has been improperly positioned.	○ Correct the position of the moving knife.	103
	④ The last stitch is skipped.	○ Correct the timing between the needle and the shuttle.	
	⑤ Bobbin thread tension is too low.	○ Increase the bobbin thread tension.	103
		⑥ Flopping of cloth	

<b>Trouble</b>	<b>Cause</b>	<b>Corrective measures</b>	<b>Page</b>
5. Stitch skipping often occurs.	<ul style="list-style-type: none"> <li>① The motions of the needle and shuttle are not properly synchronized.</li> <li>② The clearance between the needle and shuttle is too large.</li> <li>③ The needle is bent.</li> <li>④ The driver excessively bends the needle.</li> <li>⑤ Length of needle thread remaining after thread trimming is too long. (In the case of stitch skipping within the 2nd to 10th stitch from the beginning of sewing)</li> </ul>	<ul style="list-style-type: none"> <li>○ Correct the positions of the needle and shuttle.</li> <li>○ Correct the positions of the needle and shuttle.</li> <li>○ Replace the bent needle.</li> <li>○ Correctly position the driver.</li> <li>○ Reduce the thread take-up spring pressure or increase the thread tension applied by the thread tension controller No. 1.</li> </ul>	103  103 11 103  12,13
6. The needle thread comes out on the wrong side of the material.	<ul style="list-style-type: none"> <li>① The needle thread tension is not high enough.</li> <li>② The tension release mechanism fails to work properly.</li> <li>③ The needle thread after thread trimming is too long.</li> <li>④ Number of stitches is too few.</li> <li>⑤ When sewing length is short (End of needle thread protrudes on the wrong side of sewing product.)</li> <li>⑥ Number of stitches is too few.</li> </ul>	<ul style="list-style-type: none"> <li>○ Increase the needle thread tension.</li> <li>○ Check whether or not the tension disc No. 2 is released during bar-tracking.</li> <li>○ Increase the tension of the thread tension controller No. 1.</li> <li>○ Turn OFF the thread clamp.</li> <li>○ Turn OFF the thread clamp.</li> <li>○ Use the lower plate, the hole of which is larger than the presser.</li> </ul>	12     12
7. Thread end of the 1st stitch comes out on the right side of the material.	<ul style="list-style-type: none"> <li>① Stitch skipping at the 1st stitch</li> <li>② Needle used and thread used are thick in terms of the inner diameter of the intermediate presser.</li> <li>③ Intermediate presser is not properly positioned in terms of the needle.</li> </ul>	<ul style="list-style-type: none"> <li>○ Adjust the hook timing faster by a 1/2 stitch.</li> <li>○ Increase the inner diameter of intermediate presser.</li> <li>○ Adjust the eccentricity between intermediate presser and needle so that needle enters in the center of intermediate presser.</li> </ul>	
8. Threads break at time of thread trimming.	<ul style="list-style-type: none"> <li>① The moving knife has been improperly position.</li> </ul>	<ul style="list-style-type: none"> <li>○ Correct the position of the moving knife.</li> </ul>	105
9. The thread clamp is entangled with needle thread.	<ul style="list-style-type: none"> <li>① The needle thread at the sewing start is too long.</li> </ul>	<ul style="list-style-type: none"> <li>○ Tighten thread tension controller No. 1 and make the length of needle thread 40 to 50 mm.</li> </ul>	16
10. Uneven length of the needle thread	<ul style="list-style-type: none"> <li>① The tension of thread take-up spring is too low.</li> </ul>	<ul style="list-style-type: none"> <li>○ Increase the tension of the thread take-up spring.</li> </ul>	13
11. The length of needle thread does not become short.	<ul style="list-style-type: none"> <li>① The tension of thread tension controller No. 1 is too low.</li> <li>② The tension of thread take-up spring is too high.</li> <li>③ The tension of thread take-up spring is too low and motion is unstable.</li> </ul>	<ul style="list-style-type: none"> <li>○ Increase the tension of thread tension controller No. 1.</li> <li>○ Decrease the tension of thread take-up spring.</li> <li>○ Increase the tension of thread take-up spring and lengthen the stroke as well.</li> </ul>	12  13
12. The knotting section of bobbin thread at 2nd stitch at the sewing start appears on the right side.	<ul style="list-style-type: none"> <li>① Idling of bobbin is large.</li> <li>② The bobbin thread tension is too low.</li> <li>③ The needle thread tension at 1st stitch is too high.</li> </ul>	<ul style="list-style-type: none"> <li>○ Adjust the position of the moving knife.</li> <li>○ Increase the bobbin thread tension.</li> <li>○ Decrease the needle thread tension at 1st stitch.</li> <li>○ Turn OFF the thread clamp.</li> </ul>	105  12
13. Wiper fails to work. (Return is defective.)	<ul style="list-style-type: none"> <li>① Needle entry of the last needle is the same as that of the sewing start, and the resistance of thread and cloth is large.</li> </ul>	<ul style="list-style-type: none"> <li>○ Shift the needle entry point of the last needle.</li> </ul>	

## 2. OPTIONAL

### 2-1. Table of Needle hole guide

Needle used	Needle hole guide		
Size	Part No.	Needle hole diameter	Application
#09 to #11	B242621000C	ø 1.6	For knits (OP)
#11 to #14 *1	B242621000A	ø 1.6	For light-weight to medium-weight materials (S type)
#14 to #18 *2	B242621000B	ø 2.0	For medium-weight to heavy-weight materials (H type)
#18 to #21	B242621000D	ø 2.4	For heavy-weight materials (OP)
	B242621000F	ø 3.0	
#22 to #25	B242621000G	ø 3.0 (with a counterbore)	For extra heavy-weight materials (OP)
#18 to #25	B242621000H	ø 3.0 (eccentric hole)	For heavy-weight materials to prevent skip-stitching (OP)

Needle used	Intermediate presser	
Size	Part No.	Size (øA × øB × H × L)
#09 to #11	B1601210D0E (OP)	ø 1.6 × ø 2.6 × 5.7 × 37.0
#11 to #14 *1	40023632 (Standard)	ø 2.2 × ø 3.6 × 5.7 × 38.5
#14 to #18 *2	B1601210D0FA (OP)	ø 2.2 × ø 3.6 × 8.7 × 41.5
#18 to #21	B1601210D0BA (OP)	ø 2.7 × ø 4.1 × 5.7 × 38.5
#22 to #25	B1601210D0CA (OP)	ø 3.5 × ø 5.5 × 5.7 × 38.5
#18 to #25		

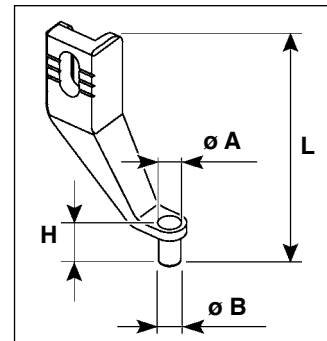

- \* 1 : Standard installed needle (DP X 5 #14)
- \* 2 : Standard installed needle (DP X 17 #18)
- S type : Applicable count of thread : #80 to #20
- H type : Applicable count of thread : #50 to #02
- (OP) means the optional.

### 2-2. Silicon oil tank



#### WARNING :

Turn OFF the power before starting the work so as to prevent accidents caused by abrupt start of the sewing machine.

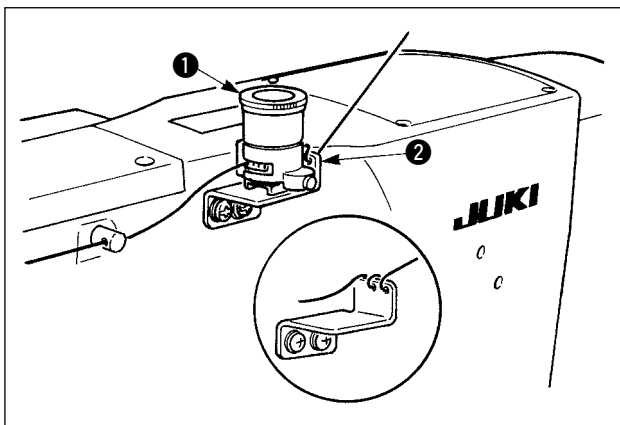

Fix silicon oil tank ❶ (MAXAP30EX00) with the magnet.



1. If the thread twists hard on silicon oil tank base ❷ (B2535210000), reverse the direction of winding the thread.
2. For fixing the silicon oil tank base, use two M4 screws.  
(Part No. of commendable screw : SM4040855SP)

